



NAUTICAL SPORTS

BOATING CATALOGUE

Feb 2022

VER 1.0

Web: <http://www.nauticalsports.co.za>

[Facebook.com/nauticalsports](https://www.facebook.com/nauticalsports)

E-mail: info@nauticalsports.co.za

Tel: +27 41 811 2628

Skype: nauticalsports

WhatsApp: 063 146 4211

TABLE OF CONTENTS

| | |
|---|----|
| <u>SAILING SPECIFIC</u> | 5 |
| <u>BLOCKS & PULLEYS</u> | 20 |
| <u>Sheeve Wheels</u> | 29 |
| <u>DECK HARDWARE</u> | 30 |
| <u>Rod Holders</u> | 30 |
| <u>Cup /Drink Holders</u> | 32 |
| <u>Inspection Hatches</u> | 33 |
| <u>Handles</u> | 35 |
| <u>Railing / Sun Canopy fittings & other Trim</u> | 36 |
| <u>Hinges & Latches</u> | 39 |
| <u>FLOWER KNOBS</u> | 44 |
| <u>BUNGS & THRU-HULLS</u> | 45 |
| <u>SCUPPERS</u> | 48 |
| <u>RIGGING HARDWARE</u> | 50 |
| <u>U / Eye Bolts</u> | 50 |
| <u>Saddles & Fairleads</u> | 52 |
| <u>Shackles & Swivels</u> | 55 |
| <u>In-Line Hooks</u> | 57 |
| <u>Fixed Hooks</u> | 59 |
| <u>ROPE MANAGEMENT / MOORING</u> | 62 |
| <u>Anchors</u> | 67 |
| <u>BOATING ACCESSORIES</u> | 68 |
| <u>SAFETY</u> | 71 |
| <u>ELECTRICAL</u> | 73 |
| <u>Switches</u> | 73 |
| <u>Lights / Navigation Lights</u> | 74 |
| <u>Battery Components</u> | 76 |
| <u>Transducer mount</u> | 78 |
| <u>Marine Pumps</u> | 79 |
| <u>OUTBOARD RELATED</u> | 82 |
| <u>Control Cables & Accessories</u> | 82 |

Cont/...

.../cont

| | |
|---------------------------------------|----|
| Steering Systems (Mechanical) | 82 |
| <u>FUEL</u> | 85 |
| <u>BOAT COVER EDEGE FASTENERS</u> | 87 |
| <u>TRAILER</u> | 90 |
| <u>Boat Rollers</u> | 90 |
| <u>Trailer Felt</u> | 92 |
| <u>Winches (Hand)</u> | 92 |
| <u>Boat Ratchet Tie Downs (Stern)</u> | 93 |
| <u>Jockey Wheels</u> | 94 |

Sailing specific



BOAT PARTS
Yacht, Dingy, Power Boat and Kayak Fittings



BG 1 (A) BURGEE (STANDARD)

(Sturdy 3mm dia tough nylon frame with wind vane and aluminium shaft. Flag 140mm X 100mm light terylene material stitched with polyester thread.

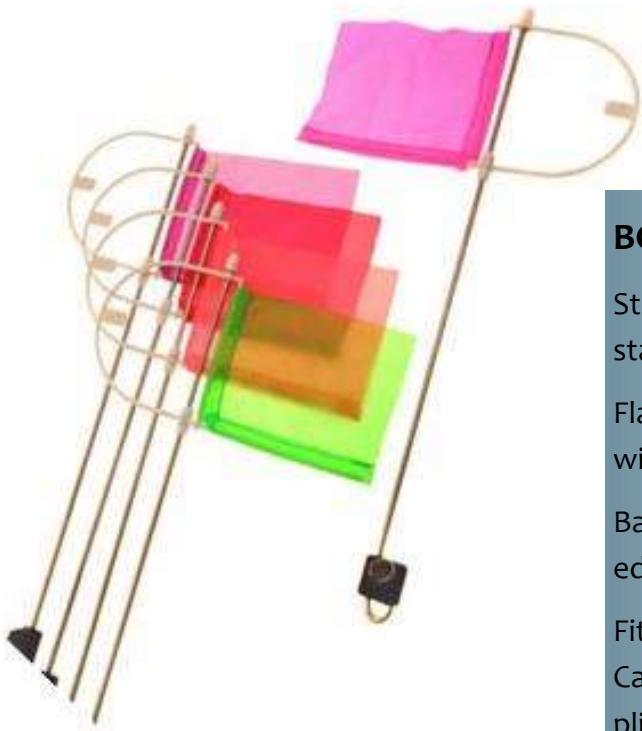

BG 1 (B) CATAMARAN BURGEE

Sturdy 3mm dia tough nylon frame with wind vane and stainless steel shaft.

Flag 140mm X 100mm light terylene material stitched with polyester thread.

Balance of Burgee can be adjusted by cutting tab provided.

Fits in upside down position on forestay chain plates of Catamarans with nylon mounting bracket and pin supplied.

BG 2 BURGEE HOLDER

Length 34mm. Suitable for 3mm or 5mm Shaft. Manufactured from black or white nylon.





BG 8 SPINNAKER BOOM or WHISKER POLE BRACKET

Curved base for easy riveting or screwing to aluminium or wooden masts from 50mm to 80mm dia.

Suitable for use with BG9, BG10 & BG11.

Manufactured from nylon.

BG 9 SPINNAKER BOOM or WHISKER POLE SPIKE

Suitable for 25mm OD dia aluminium tube.

To be used with BG8 & BG10.

Manufactured from nylon.



BG 10 SPINNAKER BOOM or WHISKER POLE HOOK

Suitable for 25mm OD dia aluminium tube.

To be used with BG8 & BG9.

Manufactured from nylon.

BG 11 SPINNAKER BOOM or WHISKER POLE JOINER

Male & female joiners with stainless steel 10mm nut & bolt.

Used to extend or shorten spinnaker boom or whisker poles.

Suitable for 25mm OD dia aluminium tube.

To be used with BG8 & BG9.

Manufactured from nylon.



**BG 99 TILLER
LOCATING PIN**
3mm dia x
61mm long.



BG 25 TILLER EXTENSION
UNIVERSAL JOINT :- 19 mm Dia



**BG 58
CATAMARAN TILLER
EXTENTION SWIVEL BUSH**

BG 23 (B)(1-4)
ROUND ALU TILLER EXTENSION

- 1) 76 cm
- 2) 1 meter
- 3) 1 meter without s/s swivel
- 4) 2 meter



BG 23 (D)(1)
TILLER EXTENSION
SWIVEL COUPLING RECTANGULAR



BG 23 (D)(2)
TILLER EXTENSION
SWIVEL COUPLING ROUND



BG 23 (E)(1-3)
TELESCOPICTILLER EXTENSIONS

- 1) 900mm to 1.4 meters
- 2) 1 meter to 1.7 meters
- 3) 1.5meters to 2 meters



BG 24 (A)
TILLER EXTENSION CLIP
RECTANGULAR :- 16mm x 10mm



BG 24 (B)
TILLER EXTENSION CLIP
ROUND :- 16mm Dia



BG 112 & 112(A) TILLER EXTENSION YOKE

S/S catamaran tiller extension yoke with clevis pin & ring.

With 40mm or 60mm long bolt.



BG 77

PLASTIC GUDGEON

Available in black nylon.

BG 125 S/S GUDGEON

With backing plate for optimist.



BG 124 S/S PINTLE FOR OPTIMIST

Pin - 24mm long x 6mm dia.

To fit 10mm rudder blade.

BG 84 S/S PINTLES

Pin - 33mm long x 9.5mm dia.

To fit 26mm rudder blade.



BG 15 RUDDER RETAINING CLIP

35mm long, used on small dinghies to prevent rudders sinking after capsizing.

Manufactured from black nylon.



BG 178(A) RUDDER STOCK

Laser 1 rudder stock.



BG 178(B) RUDDER STOCK

Laser 2 rudder stock.



BG 178(C) RUDDER STOCK

Gypsy rudder stock.



BG 110(A) CATAMARAN JIB SLIDE

Made from Glass filled nylon, total length - 84mm.

**BG 57
CATAMARAN MAST SWIVEL CHIP**



BG 69 TOP MAST TOP PLUG

Available in black nylon.

BG 72 TOP MAST SLEEVE

Available in black nylon.



BG 73

BOOM GOOSENECK PLUG

Available in black nylon.

**BG 74
TOP MAST BOTTOM PLUG**

Available in black nylon.



BG 75

BOTTOM MAST BOTTOM PLUG

Available in black nylon.





BG 67 TRAPEZE HANDLE

4mm dia Stainless Steel

Total length - 190mm

BG 81

TRAPEZE HANDLE

Made from Acetal (Hostaform).



BG 104(B) TRAPEZE HARNESS HOOK

90mm x 85mm plate with 8mm dia hook.

BG 111 S/S MAST STEP

Step width - 40mm

Step height - 140mm



BG 89(B)

S/S ADJUSTABLE MAST STEP

137.5mm long with 10 holes and 2 Clevis pins & rings.

**BG 87(A&B) S/S TANGS FOR
MASTS & BOOMS**

A - Light Duty

B - Heavy Duty

Can be bent to fit various dia.



BG 83 GOOSENECK FOR ROTATING MAST

**BG 94 S/S GOOSENECK
FOR FIXED MAST**

Straps can be adjusted for various
dia masts with 6 mounting holes 5.2mm dia.



BG 95 S/S BOOM STRAP

13mm wide straps can be adjusted for various
dia masts with 4 mounting holes 5.2mm dia.

BG 97(A-C)

BG 97 S/S MAST TANGS

A - Single light duty - 12mm wide x 40mm long with 2 x 6mm
holes

B - Single light duty - 12mm wide x 60mm long with 2 x 5mm
mounting holes and 1 x 6mm hole

C - Single heavy duty 15mm wide x 40mm long with 2 x 8mm
holes





BG 48(A-E) S/S CHAIN PLATES

A - Small - 16mm W x 100mm L

B - Medium - 19mm W x 120mm L

C - Large - 19mm W x 200mm L

D - Cover plate - 19mm W x 60mm L

E - Reinforced Heavy Duty - 20mm W x 150mm L

BG 49(A&B) S/S CHAIN PLATE ADJUSTER

A - Small

B1 - 10 Holes

B2 - 7 Holes

C - 7 Holes (heavy duty)



BG 105 S/S ROPE HOLDER

Hole Pitch - 19mm.

BG 115(A&B) SKID COVER PLATE

A) Large 73mm long x 37.5mm wide x 20mm hole

B) Small 50mm long x 28mm wide x 12mm hole



BG 115(C&D) SKID COVER PLATE (HALF SIZE)

C - 35mm long x 37.5mm wide

D - 24.5mm long x 28mm wide

BG 149(C) CABLE ENTRY COVER PLATE

**BG 149(C) CABLE ENTRY
COVER PLATE**

Used for kayak steering cables.
Size - 63mm long x 37mm wide.



BG 39(A-D) S/S CLEVIS RINGS

- A - 10mm OD x 1.1/2 coil
- B - 10mm OD x 2.1/2 coil
- C - 17mm OD x 1.1/2 coil
- D - 17mm OD x 3 coils

BG 40 (1-9) CLEVIS PINS & RINGS

- 1 - 5mm DIA x 14mm long with 1mm DIA 1.1/2 coil ring
- 2 - 5mm DIA x 20mm long with 1mm DIA 1.1/2 coil ring
- 3 - 6mm DIA x 16mm long with 1mm DIA 3 coil ring
- 4 - 6mm DIA x 23mm long with 1mm DIA 2.1/2 coil ring
- 5 - 6mm DIA x 33mm long with 1mm DIA 2.1/2 coil ring
- 6 - 10mm DIA x 12mm long with 5mm DIA split pin
- 7 - 10mm DIA x 27mm long with 5mm DIA split pin
- 8 - 5mm DIA x 10mm long with 1.1/2 coil ring
- 9 - 6mm DIA x 12mm long with 1.1/2 coil ring



BG 44(B1) S/S RIGGING LINK

Mini 3mm round bar (no pin).
Inside size 7mm x 10mm.





BG 13 NYLON RING

Used together with the nylon sail shackle BG 34 on spinnakers or jibs.

Manufactured from nylon.

BG 34 PLASTIC SAIL SHACKLE

With S/S Screw.

Available in white nylon only.



BG 32 (A&B)

PLASTIC SAIL LACING SLIDE

A - 16mm

B - 22mm

Available in black or white nylon.

BG 32 (C-G) S/S SAIL

LACING SLIDES

C - 16mm, E - 22mm,

F - 26mm, G - 23mm.





BG 127(A) SAIL BATTEN END PROTECTORS

For 10mm Battens.

Available in black or white.

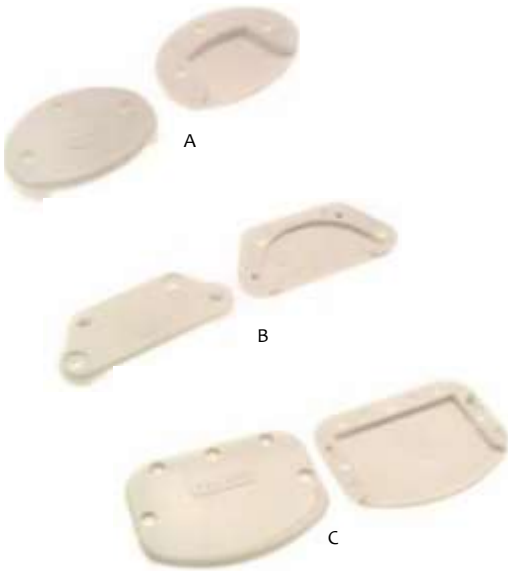

BG 128(A-C)

SAIL BATTEN PROTECTORS

A - Small - oval - Catamaran jib

B - Medium - Catamaran

C - Large - Catamaran main sail

Manufactured in white nylon.

BG 33(A&B) SAIL HEADBOARD

A - Small (100mm x 78mm) per set.

B - Medium (116mm x 101mm) per set.



BG 129 SAIL HEADBOARD

140mm x 140mm Lfit.

Manufactured in white nylon.

BG 130 CLEW PLATE

Manufactured from
black or white nylon.





BG 103 TUBULAR JAM CLEAT

Made from Acetal (Hostaform).

Hole Pitch - 54.5mm.

BG 47 S/S V JAMMING CLEAT

Hole Pitch 51mm with 2 mounting holes 5.2mm dia.



BG 22 HALLIARD CLEAT

- (A) Small : length = 65mm, hole pitch = 24mm
- (B) Medium : length = 85mm, hole pitch = 28mm
- (C) Large : length = 115mm, hole pitch = 40mm

BG 121 S/S SWIVELING CLEAT BASE

To fit various cleats.



BG 121(A) S/S SWIVELLING BASE

With ferruled bulls eye & nylon base.

BG 51 STOPS
Nylon Track Stops (Per set)



BG 51 SPACERS
Nylon Track Spacers (Per set)

BG 160 - BG 172 ALUMINIUM TRACKS

Available in various lengths with or without index pin holes & counter-sunk screw holes.

Black or natural anodising option available.

Please refer to price list for codes and options.



BG 52(A)

BG 52(A) Blank slide with nylon runners
(92mm long) Black or Natural anodised.



BG 53

Blank slide with nylon runners & index pin with knob
(92mm long) Black or Natural anodised.

BG 53(A)

Blank slide with nylon runners & index pin with pull ring
(92mm long) Black or Natural anodised.





BG 51(J)

Alu slide with index pin,
with U Bolt, swivelling ferruled fairlead
fitted with BG cam cleat and large saddle.

BG 51(K)

Alu slide with index pin,
with U Bolt swivelling ferruled fairlead
fitted to slide.



Blocks / Pulleys

**BG 50(A1) 10mm Dia Main sheet
single block with shackle mount and shackle**
Nylon Sheave Wheel dia - 44mm.



**BG 50(A2) 10mm Dia Main sheet single
block with shackle mount and shackle**
Nylon Sheave Wheel dia - 44mm.



**BG 50(A3) 10mm DIA Main sheet
double block with shackle mounting**
Nylon Sheave Wheel dia - 44mm.



**BG 50(A4) 10mm DIA Main sheet
single block with swivel mounting**
Nylon Sheave Wheel dia - 44mm.



**BG 50(A5) 10mm DIA Main sheet
double block with swivel mounting**
Nylon Sheave Wheel dia - 44mm.





BG 50(B1) 10mm DIA Main sheet

sister block with shackle mounting & shackle

Nylon Sheave Wheel dia - 44mm.

Nylon Sister Sheave Wheel - 25mm.



BG 50(B2) 10mm DIA Main sheet

sister block with shackle mounting, shackle & becket

Nylon Sheave Wheel dia - 44mm.

Nylon Sister Sheave Wheel - 25mm.



BG 50(C2) Sister block

fitted with adjustable BG cam cleat with saddle

Nylon Sheave Wheel dia - 44mm.

Nylon Sister Sheave Wheel - 25mm.



BG 50(C1) Single block

fitted with adjustable BG cam cleat with saddle

Nylon Sheave Wheel dia - 44mm.

BG 50(D1)

Large single all plastic pulley block with becket

Nylon Sheave Wheel dia - 39mm.



BG 50(D2)

Large single all plastic pulley block without becket

Nylon Sheave Wheel dia - 39mm.

BG 50(D3)

Large double all plastic pulley block with becket

Nylon Sheave Wheel dia - 39mm.



BG 50(D4)

Large double all plastic pulley block without becket

Nylon Sheave Wheel dia - 39mm.

BG 50(E1)

Small single all plastic pulley block with becket

Nylon Sheave Wheel dia - 26mm.



BG 50(E2)

Small single all plastic pulley block without becket

Nylon Sheave Wheel dia - 26mm.

BG 50(E3)

Small double all plastic pulley block with becket

Nylon Sheave Wheel dia - 26mm.



BG 50(E4)

Small double all plastic pulley block without becket

Nylon Sheave Wheel dia - 26mm.

BG 50(F1)

Single S/S small fixed eyeblock without becket

Nylon Sheave Wheel dia - 26mm.



BG 50(F1(A))

Single S/S small fixed eyeblock without becket

Brass Sheave Wheel dia - 25mm.



BG 50(F2)

Single S/S Small fixed eyeblock with becket

Nylon Sheave Wheel dia - 26mm.



BG 50(F3)

Single S/S small fixed eyeblock with side plate

Nylon Sheave Wheel dia - 26mm.



BG 50(F4)

**Single S/S small fixed eyeblock without becket
(2 pulleys linked)**

Nylon Sheave Wheels dia - 26mm.





BG 50(G1)

Single S/S miniature fixed eyeblock

Nylon Sheave Wheel dia - 17mm.

BG 50(G2)

Double S/S miniature fixed eyeblock without becket

Nylon Sheave Wheel dia - 17mm.



BG 50(G3)

Single S/S miniature fixed eyeblock with side plate

Nylon Sheave Wheel dia - 17mm.

BG 50(G4)

Triple S/S miniature fixed eyeblock

Nylon Sheave Wheel dia - 17mm.



BG 50(H1)

Mini halliard pulley

Nylon Sheave Wheel dia - 17mm.

BG 50(H2)

Halliard pulley 36mm high

Nylon Sheave Wheel dia - 26mm.



BG 50(H2(A))

Halliard pulley 36mm high with side crops

Nylon Sheave Wheel dia - 26mm.





BG 101(A1) SINGLE MINI BLOCK

With metal sides, without becket and 25mm dia sheave wheel.

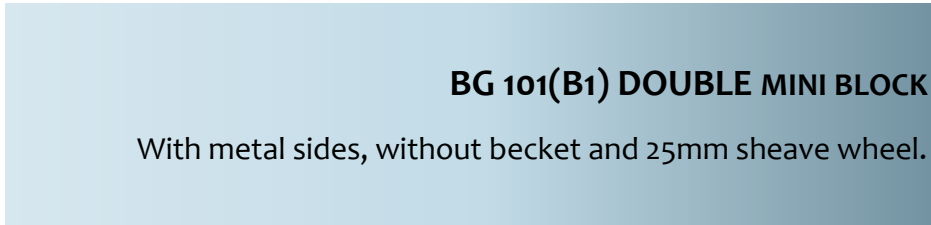

BG 101(B1) DOUBLE MINI BLOCK

With metal sides, without becket and 25mm sheave wheel.



BG 101(A2) SINGLE MINI BLOCK

With metal sides, becket and 25mm sheave wheel.



BG 101(B2) DOUBLE MINI BLOCK

With metal sides, becket and 25mm sheave wheel.



BG 101(C1) TRIPLE MINI BLOCK

With metal sides, without becket and 25mm dia sheave wheels.



BG 101(C2) TRIPLE MINI BLOCK

With metal sides, becket and 25mm dia sheave wheels.



BG 101(D1) SINGLE BLOCK

With metal sides, without becket and
50mm dia sheave wheel.



BG 101(D2) SINGLE BLOCK

With metal sides, becket and
50mm dia sheave wheel.



BG 101(E1) DOUBLE BLOCK

With metal sides, without becket and
50mm dia sheave wheel.



BG 101(E2) DOUBLE BLOCK

With metal sides, becket and
50mm dia sheave wheel.

BG 101(F1) SINGLE BLOCK

With metal sides, without becket and
80mm dia sheave wheel.



BG 101(F3) SINGLE BLOCK

With metal sides, becket and
80mm dia sheave wheel.

BG 108 (C) DOUBLE CHEEK BLOCK

80mm long x 25mm wide with 25mm dia x 8.5mm sheave wheel with flat or curved base.



BG 108 (A&E) SINGLE CHEEK BLOCK

80mm long x 25mm wide with 25mm dia x 8mm or 12mm sheave wheel with flat or curved base.



BG 108(B) SINGLE CHEEK BLOCK

90mm long x 45mm wide with 44mm x 12mm dia sheave wheel with flat or curved base.

BG 108(D) DOUBLE CHEEK BLOCK

90mm long x 44mm wide with 44mm dia x 12mm sheave wheel. Flat or curved base.



BG 135 STEERING PULLEY BLOCK

39mm dia nylon Sheave wheel.

BG 113 S/S CLEW BLOCK

Sheave wheel 25mm dia x 12mm wide.



BG 118(A-D) ROPE SHEAVE BOXES

- A - Single Rope sheave box with 25mm black or white plastic sheave
- A1 - Double Rope sheave box with 25mm black or white plastic sheave
- B - Single Rope sheave box with 44mm black or white plastic sheave
- B1 - Double Rope sheave box with 44mm black or white plastic sheave
- C - Single Wire sheave box with 25mm Brass sheave
- D - Single Wire sheave box with 44mm Brass sheave



Sheave Wheels

BG 21 NYLON & HOSTA-FORM SHEAVE WHEELS

BG 021(A)(1) – NYLON 25mm DIA X 12mm
Wide X 7mm Hole

BG 021(A)(2) – HOSTAFORM 25mm DIA X
12mm Wide X 7mm Hole

BG 021(A)(3) – NYLON 25mm DIA X 12mm
Wide X 8.5mm Hole

BG 021(B)(1) – NYLON 26mm DIA X 9mm
Wide X 8.5mm Hole (recessed side walls)

BG 021(B)(2) – HOSTAFORM 26mm DIA X
9mm Wide X 8.5mm Hole (recessed side
walls)

BG 021(C)(1) – NYLON 39mm DIA X 12mm
Wide X 8.5mm Hole

BG 021(C)(2) – HOSTAFORM 39mm DIA X
12mm Wide X 8.5mm Hole

BG 021(D)(1) – NYLON 44mm DIA X 12mm
Wide X 8.5mm Hole

BG 021(D)(2) – HOSTAFORM 44mm DIA X
12mm Wide X 8.5mm Hole

BG 021(E)(1) – NYLON 50mm DIA X 14mm
Wide X 10.5mm Hole

BG 021(E)(2) – HOSTAFORM 50mm DIA X
14mm Wide X 10.5mm Hole

BG 021(F)(1) – NYLON 65mm DIA X 17mm
Wide X 12.5mm Hole

BG 021(F)(2) – HOSTAFORM 65mm DIA X
17mm Wide X 12.5mm Hole

BG 021(G)(1) – NYLON 80mm DIA X 19mm
Wide X 12.5mm Hole

BG 021(G)(2) – HOSTAFORM 80mm DIA X
19mm Wide X 12.5mm Hole

BG 021(I)(1) – NYLON 17mm DIA X 6mm
Wide X 8.5mm Hole

BG 021(I)(2) – WHITE NYLON 17mm DIA X
6mm Wide X 8.5mm Hole



BG 21 Stainless Bushes

BG 021(B)(3) - S/S BUSH TO FIT 26mm X 9mm X
8.5mm (Bush 10mm long)

BG 021(D)(3) - S/S BUSH TO FIT 44mm X 12mm X
8.5mm (Bush 13mm long)

BG 021(E)(3) - S/S BUSH TO FIT 50mm X 14mm X
10.5mm (Bush 15mm long)

BG 021(F)(3) - S/S BUSH TO FIT 65mm X 17mm X
12.5mm (Bush 18mm long)



Deck hardware

Rod holders



BG137A

Plastic Tube with plastic clamps



BG137C

Plastic Tube only



BG137D

S/S Rod holder tube only
38mm OD tube x 200mm long with pin



BG137E

Trolling rod holder
35mm dia tube 200mm long



BG137B

Trolling rod holder
35mm ID S/S tube with plastic base clamps



BG137(F&G) Trolling Rod Holders

F - Large - 48mm ID tube with S/S base
G - Small - 37mm ID tube with S/S base

BG137(I)

Trolling Rod Holder
35mm dia S/S tube x 200mm long
with single stud 8mm dia x 20mm long





BG142(A&A1) 90° ROD HOLDERS

Total height from under head - 150mm ID - 35mm

A - Open bottom

A1 - Closed bottom

BG142(B&B1) 50° ROD HOLDERS

Total height from under head - 150mm ID - 35mm

B - Open bottom

B1 - Closed bottom



Available in black or white ABS plastic

B5-035-2

Rod Holder With Flush Deck Mounting



B5-034-2

Rod Holder With Flush Deck Mounting



B5-051-1

Rod Rack (6)
Horizontal
Pair



B5-051-2

Rod Rack (6) Vertical
Set



Cup holders



BG 131

BG 131 CUP HOLDERS

Available in black or white nylon.



CB54091

Drink Holder PVC FLEXIBLE



FDH

Folding Drink Holder BLACK

99232 - Black

94161 - White

Drink Holder – Store All BLK/WHT



99826 - Black

99827 - White

Drink Holder Support Base used to mount 99232/94161 – BLK/WHT



Inspection / storage hatches



BG141(A-F)

BG 141(A-F) INSPECTION HATCH COVERS

Available in black, white & grey or with a clear lid option.

Sizes available

A - 6" (152mmID / 205mm OD)

B - 4" (100mmID / 155mm OD)

C - 6" (152mm) clear lid

D - 4" (100mm) clear lid

E - 8" (200mmID / 260mm OD)

F - 8" (200mm) clear lid

Ring & lid available separately.

CL-HB

INSPECTION HATCH COVERS with PVC bags for waterproof storage compartments (PVC with welded seams, glued to ring).

Available in black & grey

Sizes available

CL-HB4 - 4" (100mmID / 155mm OD)

CL-HB6 - 6" (152mmID / 205mm OD)

CL-HB8 - 8" (200mmID / 260mm OD)



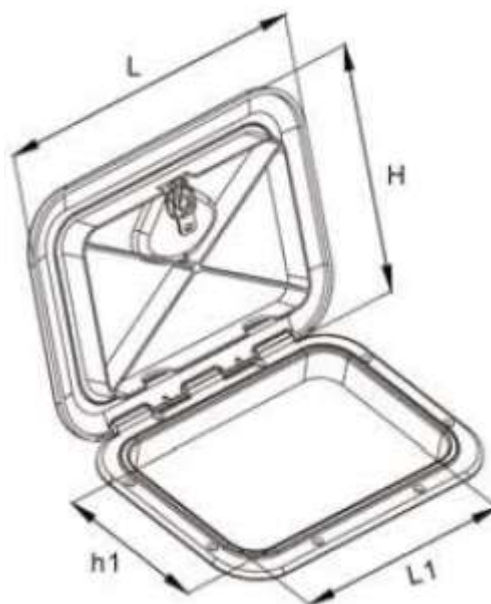

| Model | H(mm) | L(mm) | h1(mm) | L1(mm) |
|------------------|-------|-------|--------|--------|
| SFRE1-270-375-01 | 270 | 375 | 192 | 291 |

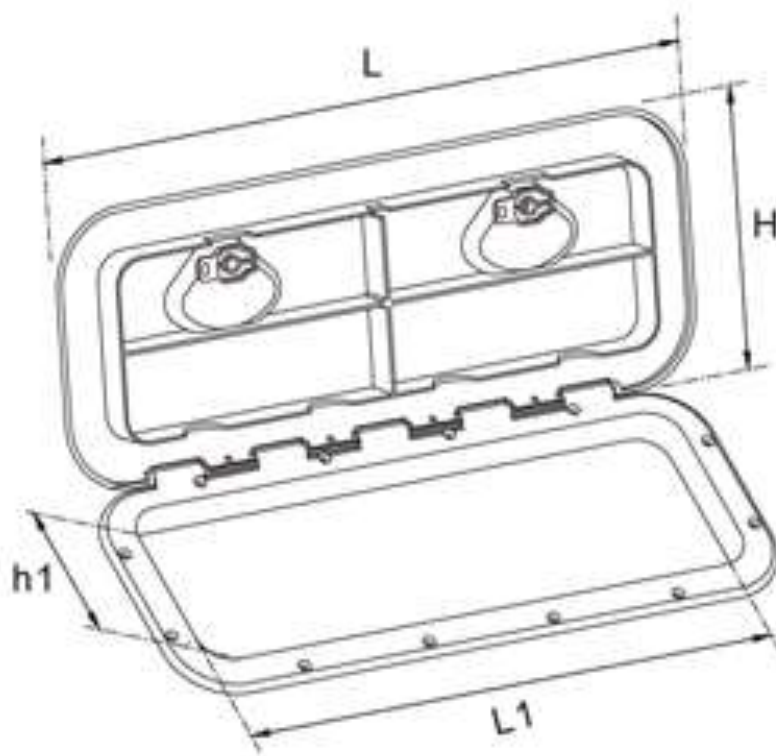

| Model | H(mm) | L(mm) | h1(mm) | L1(mm) |
|------------------|-------|-------|--------|--------|
| SFRE1-243-607-01 | 243 | 607 | 168 | 525 |
| SFRE1-315-440-01 | 315 | 440 | 240 | 358 |
| SFRE1-353-606-01 | 353 | 606 | 278 | 524 |
| SFRE1-370-375-01 | 370 | 375 | 295 | 295 |
| SFRE1-460-510-01 | 460 | 510 | 383 | 436 |

Handles

BT 022(A) & (B)

Handles : 2 Mounting Holes

(A) 245mm Long

(B) 215mm Long

Available in Black & Grey



BT 022 (C)

Handle : 1 Mounting Hole

(C) 245mm Long

Available in Black only

B5-033-1

Handle - Very Heavy Duty

4 Mounting Holes

Available in Black only



Railing / Sun Canopy fittings & other Trim



BG 119

Windscreen Bracket

BG 65(A-C)

GRAB RAILINGS

A - End fitting with backing plate & 2 screws.

B - Tee pieces with backing plate & 2 screws.

Available in black or white nylon.



BG 106(A) PULPIT RAIL CLAMP

For 25mm dia tube made from black nylon.

BG 106(B) PULPIT RAIL CLAMP

For 19mm dia tube made from black nylon.



BG 82(A1)

JAW SLIDE WITH EYE END

To be used with 22.2mm Alu tube.

Available in black or white nylon.

BG 82(B1)

DECK HINGE WITH EYE END

To be used with 22.2mm Alu tube.

Available in black or white nylon.





BG 82(A2)

JAW SLIDE WITHOUT EYE END

To be used with 22.2mm Alu tube.

Available in black or white nylon.

BG 82 (A3 & A4)

DOUBLE JAW SLIDE

With or without Eye End.



BG 82(B2) DECK HINGE ONLY

Available in black or white nylon.

BG 82(C) EYE END ONLY

To be used with 22.2mm Alu tube.

Available in black or white nylon.



BG 82(D) SIDE MOUNT DECK HINGE WITH EYE END

To be used with 22.2mm Alu tube.

Available in black or white nylon.

BG 82(E) BG 82(E) SIDE MOUNT DECK HINGE ONLY

Available in black or white nylon.





BG 82(F) DECK HINGE WITH EYE END AND WING NUT

To be used with 22.2mm Alu tube.

Available in black or white nylon.

BG 82(I) WITH WING NUT ONLY

To be used with 22.2mm Alu tube.

Available in black or white nylon.



BG 76

BEADING ENDS

Available in black nylon.

Hinges & Latches

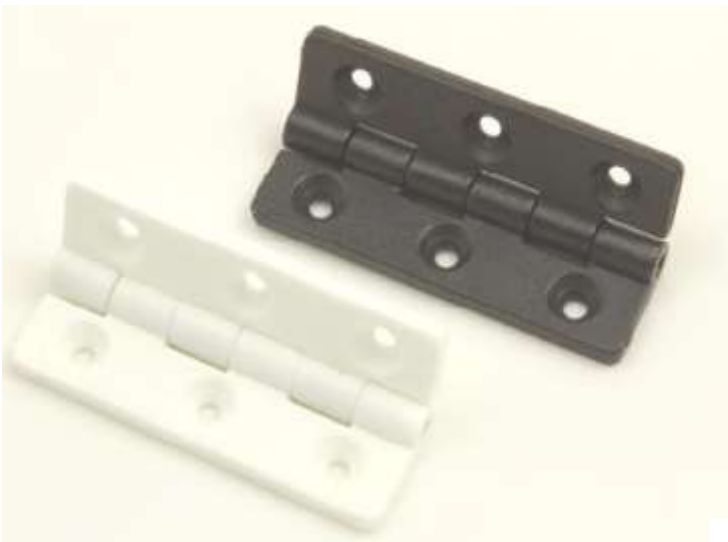

BG 116 (A), (B) & (C)

Plastic hinges with Stainless pin

Available in Black or White Nylon

(A) Small 40mm x 18mm closed

(B) Medium 55mm x 19mm closed

(C) Large 70mm x 25mm closed

Retail Pack: Qty 2 **W/Sale:** Bag of 50

BG 116 (D)

Large Plastic Hinge Heavy Duty

78mm x 43mm closed

Available in Black & White Nylon

Retail Pack: Qty 2 **W/Sale:** Bag of 50



BG 116 (F)

Plastic Hinge Heavy Duty 50mm x 44mm closed

(Black & White Nylon)

Retail Pack: Qty 4 **W/Sale:** Bag of 50



BG 116 (E)

Plastic Hinge Small 2 hole

46mm x 24.5mm closed

Available in Black & White Nylon

Retail Pack: Qty 2 **W/Sale:** Bag of 50





DH - Stainless Butt Hinges 316 grade

DH5940 - 59 x 40mm - 3 hole

DH4040 - 40x 40mm - 2 hole

Retail Pack: Qty 2 **W/Sale:** 10



7065X - Stainless Butt Hinges 316 grade

70652- A=38mm, B=39mm

70654 - A=48mm, B=39mm

Thickness=1.5mm, C=5mm

Retail Pack: Qty 2 **W/Sale:** 10



DH - Nylon Hinges

DH6038BN - 60 x 38mm

DH7938BN - 79 x 38mm

Retail Pack: Qty 2 **W/Sale:** 10



BG 175 (1)

Door & Cupboard Catch
(Female large back mount)

Retail Pack: Qty 6 / **W/Sale:** Bag of 50



BG 175 (2)

Door & Cupboard Catch
(Female Small side mount)

Retail Pack: Qty 6 / **W/Sale:** Bag of 50



BG 175 (3)

Door & Cupboard Catch
(Male Standard back mount)

Retail Pack: Qty 6 / **W/Sale:** Bag of 50



BG 175 (4)

Door & Cupboard Catch
(Male 90 degree back mount)

Retail Pack: Qty 6 / **W/Sale:** Bag of 50



BG 175 (5)

Door & Cupboard
Catch spacer pad

Retail Pack: Qty 6
W/Sale: Bag of 50



BG 140

Plastic Hasp & Staple

Available in Black & White Nylon

Retail Pack: Qty 2 / **W/Sale:** Bag of 50



4928 - Hasp & Staple - Non-Twist

Marine Grade 316 Stainless Steel

(All screws hidden when closed for additional security)

Retail Pack: Qty 1 / **W/Sale:** Bag of 10



4935 - Hasp & Staple - Twist

Marine Grade 316 Stainless Steel

(All screws hidden when closed for additional security)

Retail Pack: Qty 1 / **W/Sale:** Bag of 10



Adjustable and lockable Stainless Canopy Latch (304 grade)

701SS 83-89mm

702SS 91-120mm

703SS 141-164mm

Retail Pack: Qty 2

Retail Pack: Qty 1

Retail Pack: Qty 1

W/Sale: Bag of 50

W/Sale: Bag of 50

W/Sale: Bag of 50



2770

Mini throw over catch - Nickle plated mild steel

Retail Pack: Qty 1 / W/Sale: Bag of 10

TH140A1

Rubber Bonnet Catch Set

Sold in Pairs

Metal Parts = Galvanized



98718 Pull Ring

Pull Ring 55x65 mm

316SS

Flower Knobs

BG61(A-E) KNOBS WITH S/S NUTS & BOLTS

- (A) 20mm dia head with 5mm thread x 20mm long
 - (A1) 20mm dia head with 5mm nut
- (B) 40mm dia head with 6mm thread x 25mm long
 - (B1) 40mm dia head with 6mm nut
- (C) 50mm dia head with 8mm thread x 30mm long
 - (C1) 50mm dia head with 8mm nut
- (C2) 50mm dia head with 10mm thread x 30mm S/S bolt
 - (D2) 73mm dia head with 12mm full nut
- (E) 40mm dia head with 8mm thread right through



BG 82 KNOBS WITH 6mm S/S BOLT

- (G) 25mm
- (G2) 40mm



BEVTENT 046

3 Prong Knob

- A) 10mm dia x 36mm bolt S/Steel
- B) 8mm dia x 36mm bolt S/Steel
- C) 12mm dia x 36mm bolt S/Steel



BEVTENT 046

Spacer Bush

- A1) 10mm dia hole.
- B1) 8mm dia hole.
- C1) 12mm dia hole



Bungs and Thru-hulls



BG 17(A) DECK BUSH (SMALL)

The small Deck Bush fits into a 16mm hole.
Has a 10mm inside dia hole with a 28mm screw hole pitch.
Suitable for rope up to 8mm dia.
Manufactured from black or white nylon.

BG 17(B) DECK BUSH (LARGE)

The Large Deck Bush fits into a 22mm hole.
Has a 16mm inside dia hole with a 33mm screw hole pitch.
Suitable for rope up to 12mm dia.
Manufactured from black or white nylon.



BG 19 (B) PUSH-IN BUNG

Push-in Bung only. Fits in BG17(B)
Manufactured from black polyethylene.

BG20 (A) TRANSOM DRAIN SOCKET WITH BUNG & SEALING RING

Used for draining water from boat hulls, hatches or containers.
Manufactured from black or white nylon.



BG 20 (A)(2) DRAIN SOCKET ONLY

Socket with retaining ear on side.
Socket fits into hole 25mm dia.
Screw hole pitch 39mm

BG 20 (B) BUNG & SEAL ONLY

Used with BG 20 (A2) socket.
Complete with sealing rubber ring



BG 20 (B) (1)

Bung Seal only, used with BG 20. (B)



BG 176 BREATHER BUNG

Kayak breather bung with large deck bush.

BG 122(A & C) EXPANDING RUBBER TRANSOM DRAIN BUNG

BG122(A) - With 6mm S/S nut & bolt
to fit 22mm ID tube.

BG 122(C) - With 6mm S/S nut & bolt
to fit 19mm ID tube.

Available in Black or White



BG 122(B & D) S/S TUBE FOR EXPANDING BUNG

B - 23mm ID x 25mm OD x 50mm long

B1 - 23mm ID x 25mm OD x 75mm long

B2 - 23mm ID x 25mm OD x 60mm long

B3 - 23mm ID x 25mm OD x 65mm long

B4 - 23mm ID x 25mm OD x 80mm long

B5 - 23mm ID x 25mm OD x 85mm long

B6 - 23mm ID x 25mm OD x 90mm long

D - 19mm ID 22mm OD x 41mm long

Manufactured from 316 S/S.



BG 122(B7 & D1) PLASTIC TUBE WITH FLANGE FOR EXPANDING BUNG

BG122(B7) - 23mm ID x 36mm long x 30.5mm OD

BG122(D1) - 19mm ID x 35.5mm long x 27.5mm OD

Available in Black or White





BG 122(E) EXPANDING RUBBER TRANSOM DRAIN BUNG

With 8mm S/S nut & shaft to fit 42mm ID tube.

BG 55 SKINFITTING

Complete - 3 parts - 36mm thread dia x 40mm to fit 25mm ID pipe.
Total length 88mm.
Available in black or white.



BG 56

Push in bung for skinfitting

BG122(A) EXPANDING BUNG also fits in BG55 SKIN FITTING (Remove grid)



BG 107 SMALL SCREWED COCKPIT DRAIN OR SKINFITTING

To fit 19mm ID pipe

Available in black or white nylon.

Scuppers

BG 123(A) SMALL TRANSOM SCUPPER

Small Plastic scupper with ball and seal.

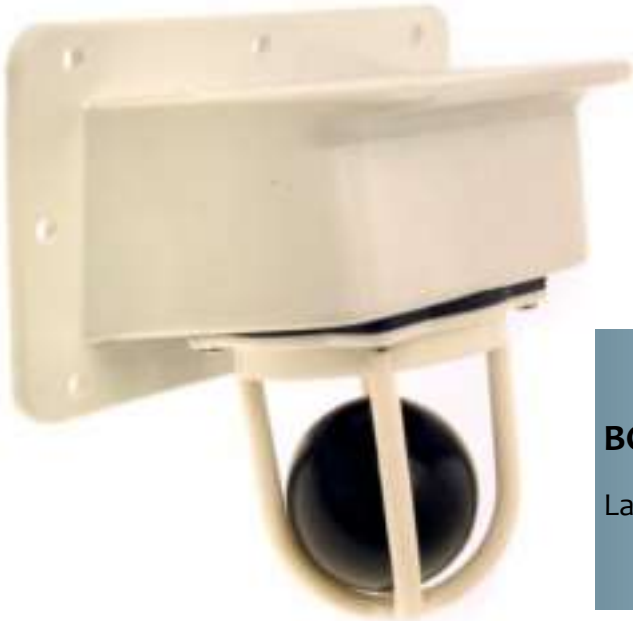

BG 123(D) LARGE TRANSOM SCUPPER

Large plastic scupper with ball and seal.



BG 123(C & E) SCUPPER CAGE ONLY

BG123(C) Small - to be used with BG123(A)

BG123(E) Small - to be used with BG123(D)



BG 123(H - I) PLASTIC BALL & SEAL Sets

H - Small scupper rubber seal & ball

I - Large scupper rubber seal & ball



BG 123(G1) HARD PLASTIC BALL

For inflatable boat scupper.





BG 123(G) SCUPPER

White Inflatable boat scupper with hard ball.

BG 123(K)

DUCK BILL SCUPPER (COMPLETE)



Rigging hardware

U / Eye - bolts



BG86 (C-D) Eye Bolts

C - 8mm x 21mm ID x 100mm long - welded

D - 6mm x 12mm ID x 55mm long - welded

D1 - 6mm x 12mm ID x 80mm long - not welded

D2 - 6mm x 12mm ID x 55mm long - not welded

R4-027- Eye Bolts

R4-027-6 Eye Bolt Welded 6x80 316SS

R4-027-8 Eye Bolt Welded 8x100 316SS

R4-027-10 Eye Bolt Welded 10x100 316SS



BG 86(A-B) S/S EYE BOLTS

A - 8mm dia x 110mm long

B - 8mm dia x 170mm long

BG 7 U:BOLT FERRUED FAIRLEAD

8mm dia stainless steel U-Bolt, 42mm pitch, 90mm long thread with S/steel nuts & backing plate. It has a nylon plastic insert with a S/steel ferrule. Used with rope up to 16mm.



BG 92 S/S SHROUD U BOLT

39mm Pitch, 6mm dia with 4 nuts & 4 washers.



BG 153 - BG158 U-BOLTS

All U-Bolts come with plastic nut covers and plates (unless otherwise stated below).

Manufactured from 316 stainless steel.

BG153(A) - U BOLT 4mm x 42mm PITCH x 100mm THREAD

BG154(A) - U BOLT 5mm x 42mm PITCH x 100mm THREAD

BG155(A) - U BOLT 6mm x 16mm PITCH x 25mm THREAD

BG155(B) - U BOLT 6mm x 16mm PITCH x 56mm THREAD

BG155(D) - U BOLT 6mm x 31mm PITCH x 45mm THREAD

BG155(H) - U BOLT 6mm x 42mm PITCH x 100mm THREAD

BG156(A) - U BOLT 8mm x 42mm PITCH x 35mm THREAD

BG156(B) - U BOLT 8mm x 42mm PITCH x 60mm THREAD

BG156(B1) - U BOLT 8mm x 42mm PITCH x 60mm THREAD (no plates, no nuts)

BG156(C) - U BOLT 8mm x 42mm PITCH x 100mm THREAD

BG156(D) - U BOLT 8mm x 42mm PITCH x 150mm THREAD

BG157(A) - U BOLT 10mm x 42mm PITCH x 125mm THREAD

BG157(AA) - U BOLT 10mm x 42mm PITCH x 70mm THREAD (no plates, no nuts)

BG157(F) - U BOLT 10mm x 42mm PITCH x 35mm THREAD

BG157(H) - U BOLT 10mm x 70mm PITCH x 40mm THREAD (no plates, no nuts)

BG158(A) - U BOLT 12mm x 45mm PITCH x 170mm THREAD

BG158(B) - U BOLT 12mm x 45mm PITCH x 200mm THREAD

BG158(C) - U BOLT 12mm x 45mm PITCH x 250mm THREAD

BG158(F) - U BOLT 12mm x 70mm PITCH x 180mm THREAD (no plates, no nuts)

**BG156(G) & BG 157(G) DEAD EYE to fit U-BOLT**

BG156(G) - DEAD EYE to fit 8mm U-BOLTS

BG157(G) - DEAD EYE to fit 8mm U-BOLTS



Saddles & Ferrules



BG 3 FIXED FAIRLEAD

Length 68mm. Screw hole pitch 48mm.

Suitable for rope maximum 16mm.

Manufactured from black or white nylon.

BG 4 (A) BULLSEYE FAIRLEAD (Small)

Base 26m. Screw hole pitch 15mm. Suitable for rope up to 6mm.

Manufactured from black or white nylon.



BG 4 (B) BULLSEYE FAIRLEAD (Large)

Base 40mm. Screw hole pitch 24mm. Suitable for rope up to 10mm.

Manufactured from black or white nylon.

BG 5 FERRULED BULLSEYE FAIRLEAD (Large)

Base 40mm. Screw hole pitch 24mm. Suitable for rope upto 10mm.

With stainless steel ferrule. Manufactured from black or white nylon.



BG 6 DEADEYE FAIRLEAD

Base 40mm. Screw hole pitch 24mm. Suitable for rope up to 10mm.

Manufactured from black or white nylon.

BG 45(A) S/S SADDLE SMALL

Hole Pitch 32mm. Height - 14mm inside size. 5.2mm holes.



BG 45(B) S/S SADDLE - LARGE

Width 13mm. Hole Pitch 41mm. Height 14mm inside size. 5.2mm Holes.

BG 45(C) PLASTIC SADDLE - EYESTRAP

Hole Pitch 34mm. Height 8mm inside size. 4.5mm dia holes.

Available in black or white nylon.





BG 45(D) S/S MINI SADDLE

Hole Pitch 20mm. Height 7mm inside size. 4mm dia holes.

BG 45(E & K) S/S COLLAPSIBLE SADDLE ROUND

BG45(E) - 25mm D-ring, with 2 mounting holes 5mm dia

BG45(K) - 20mm D-ring, with 2 mounting holes 4mm dia



BG 45(F) S/S COLLAPSIBLE SADDLE SQUARE

For 25mm webbing, with 2 mounting holes 5mm dia

**BG 45(G) S/S DOUBLE COLLAPSIBLE
RECTANGULAR SADDLE**

For 50mm webbing with 4 mounting holes 5mm dia.

With a 4mm dia rectangular loop.



BG 45(H) S/S S/S COLLAPSIBLE FISH PLATE SADDLE ROUND

For 25mm webbing with 1 mounting hole 5mm dia. With a 4mm dia loop.



BG 45(I) S/S S/S COLLAPSIBLE FISH PLATE SADDLE SQUARE

For 25mm webbing with 1 mounting hole 5mm dia. With a 4mm dia loop.



**BG 45(J) S/S S/S COLLAPSIBLE FISH PLATE
TRIANGULAR SADDLE**

For 25mm webbing with 1 mounting hole 5mm dia. With a 4mm dia loop.



BG 90(A) S/S ROPE SADDLE

Width 16.5mm, Hole Pitch 39mm.

Height 14mm inside size, 5.2mm Holes.

BG 90(B) S/S ROPE YOKE

16.5mm inside width,

13mm wide with 5.2mm holes.



Shackles & Swivels

BG 41 S/S SWIVEL

With 2 Clevis Pins & Rings. Inside sizes = 11mm x 8mm



BG 43 (A) S/S BASE

10mm swivel pin & strip shackle. Base 39mm square.

BG 43(B) S/S BASE

Swivelling "U" bracket and clevis pin. Base 39mm square.



BG 42 (A - B) S/S SHACKLES

A - Strip shackle - small - 9 x 18

A1 - Strip shackle - small / wide - 9 x 20

B - Strip shackle - large - 16 x 38

BG42(A)

BG42(A1)





R4-006- SS DEE SHACKLES

R4-006-750 Dee Shackle - S/S 4mm 750Kg

R4-006-1200 Dee Shackle - S/S 5mm 1200Kg

R4-006-1750 Dee Shackle - S/S 6mm 1750Kg

R4-006-3000 Dee Shackle - S/S 8mm 3000Kg

R4-006-5800 Dee Shackle - S/S 10mm 5800Kg

R4-005- GALV DEE SHACKLES

R4-005-100 Dee Shackle - GALV 6mm 100Kg

R4-005-200 Dee Shackle - GALV 8mm 200Kg

R4-005-320 Dee Shackle - GALV 10mm 320Kg

R4-005-520 Dee Shackle - GALV 12mm 520Kg

R4-005- Dee Shackle - GALV 16mm



R4-004- QUICK LINKS

R4-004-3.5 Quick Link - S/S - 3.5mm

R4-004-4 Quick Link - S/S - 4mm

R4-004-5 Quick Link - S/S - 5mm

R4-004-6 Quick Link - S/S - 6mm

R4-004-7 Quick Link - S/S - 7mm

R4-007-8 Quick Link - S/S - 8mm

R4-007-12 Quick Link - S/S - 12mm

CHAIN

CHAIN-6MM-ELECTRO - Electro-Plated - 6mm

CHAIN-6MM-GALV - Hot-Dipped Galvanized 6mm

CHAIN-8MM-GALV - Hot-Dipped Galvanized 8mm

CHAIN-6MM-SS - INOX316 ISO 4565/DIN CALIBRATED 6mm



In-line hooks

BG 85 (A), (B) & (C)

Andy Hook for Rope / Bungie (Black or White Nylon)

- (A) Small (Use 2-4mm Bungie)
- (B) Medium (Use 4-6mm Bungie)
- (C) Large (Use 6-8mm Bungie)



SPRING-GATE SNAP

Marine Grade 316 Stainless Steel Cast Hook
30mm / 50mm / 70mm / 100mm



Snap Hook Carabiners

Galvanized or Marine Grade 316 Stainless Steel
With or without eyelet
4mm—12mm



Snap Hook with twist lock

Marine Grade 316 Stainless Steel
6mm or 10mm

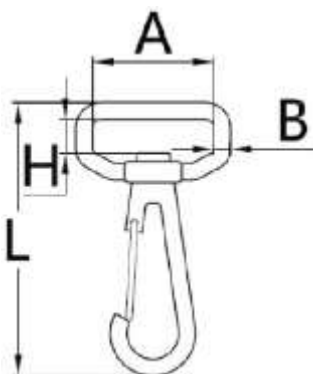

SWIVEL SPRING SNAP

Marine Grade 316 Stainless Steel
A = 25mm B = 4mm
H = 8mm L = 65mm



DE-STRAP-HOOK-SS

Rated SS hook, ideal for winch straps

Break Load tested to 1100Kg



BG 117(A), (B), (C) & (D) S/S "S" HOOKS

(A) 6mm dia - total length 49mm

(B) 8mm dia - total length 53mm

(C) 5mm dia - total length 55mm

(D) 3mm dia - total length 30mm



BG138(E1)

S/Steel 304 D-Ring with Hook 4mm dia x 25mm wide

BT 040

S/Steel 304 Twisted "S" Hook



Fixed hooks

BG12 (A)

Quick Release spring clip
(Black or White Nylon)



BG26 Flare Holder

(A) Small 30mm ID
(B) Large 40mm ID
(Black or White Nylon)



BG16 (A)

Lacing Hook
(Black or White Nylon)



AWPAR 031

Rope Tensioner

(No Base, Large Head)



AWPAR 031 (B)

Rope Tensioner

(Large Base, Small Head)



AWPAR 031 (C)

Rope Tensioner

(Large Base, Large Head)

BG91

S/Steel 316 Hook

13mm wide, 2 mounting holes 5.2mm dia. Total height 41mm





BEVTENT 051 (A)

Cupped



BEVTENT 051 (B)

Utility



BEVTENT 051 (C)

Picture hanger

PLASTIC HOOKS

BEVTENT 051 (D)

Large double





BG14 (B) TOESTRAP WASHER

With 4.5mm hole. Used for securing 25mm webbing.
Manufactured from black or white nylon.

BG14 (C) TOESTRAP DOMED WASHER

With 5mm hole. Used for securing 25mm webbing.
Manufactured from black nylon.



BG14 (A & D) TOESTRAP PLATE

Used with 4mm counter sunk screws.

Used for securing buoyancy bags or a webbing toestrap.

BG14(A) - 50mm long x 18.5mm wide with 28mm pitch screw holes.

BG14(D) - 30mm long x 16mm wide with 13mm pitch screw holes.

Manufactured from black or white nylon.



Rope Management / Mooring

BG 148 ROPE REEL

Reel size - 280mm dia x 300mm wide.

Suitable for rope up to 12mm dia.

Rope not included.



BG 146 SHOCK CORD CLAMP

Plastic. Suitable for use with 6mm dia shock cord or rope.

Cord/Rope not supplied.

BG 62 ROPE END STOPPERS

Available in various colours.



BG 30 (A&B)

WEDGE CLEAT

(A) - Small :- Hole Pitch 36mm

(B) - Large :- Hole Pitch 68mm

Available in black or white (Acetal).



AWPAR 27

S/S (304) Bar Cleat 87mm Long x 6mm dia.

BG 66 (A) & (B)

Bar Cleat (Black or White Nylon)

(A) Small 150mm long (M6 CSK holes)

(B) Large 200mm long (M6 CSK holes)



AWPAR 19

190mm long Bar Cleat

(Black or White Nylon)



BG 47 S/S V JAMMING CLEAT

Hole Pitch 51mm with 2 mounting holes 5.2mm dia.



BG 103 TUBULAR JAM CLEAT

Made from Acetal (Hostaform). Hole Pitch - 54.5mm.

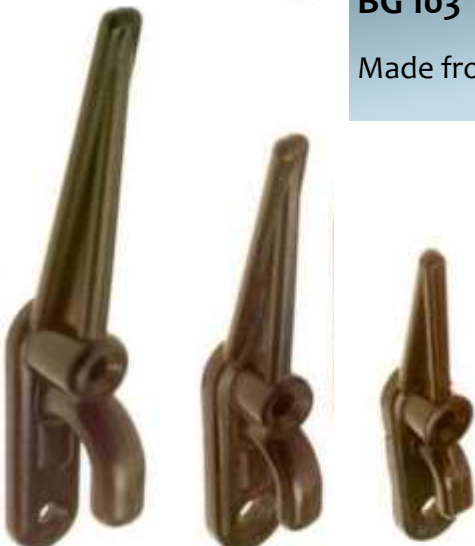

BG 22 HALLIARD CLEAT

(A) Small : length = 65mm, hole pitch = 24mm

(B) Medium : length = 85mm, hole pitch = 28mm

(C) Large : length = 115mm, hole pitch = 40mm



BG 27 ALL PLASTIC

CAM CLEAT

Hole Pitch :- 42 mm.

BG 28 (A1) BG CAM CLEAT

Small with S/S base.

Hole Pitch :- 42mm.



BG 28(A2) BG CAM CLEAT

Small with S/S base & S/S saddle.

Hole Pitch :- 42mm.

BG 28(B1) BG CAM CLEAT

Small with plastic base.

Hole Pitch :- 42mm.



BG 28(B2) BG CAM CLEAT

Small with plastic base & S/S saddle.

Hole Pitch :- 42mm.

BG 28(C1)BG CAM CLEAT

Large with S/S base.

Hole Pitch :- 48mm.



BG 28(C2) BG CAM CLEAT

Large with S/S base & S/S saddle.

Hole Pitch :- 48mm.



BG 28(D1) BG CAM CLEAT

Large with plastic base.

Hole Pitch :- 48mm.

BG 28(D2) BG CAM CLEAT

Large with plastic base & S/S saddle.

Hole Pitch :- 48mm.



BG 28(F) MINI CAM CLEAT

49mm wide with or without rope guide.

Hole Pitch :- 28mm.

BG 29 BG EYE CLEAT

With S/S Base and rope guide.

Hole Pitch :- 48mm.





BG 79(A)

BG 79(A&A1) SMALL BOW ROLLER

Total length - 200mm long x 90mm wide

Roller wheel - 52mm dia x 38mm wide



BG 79(B)

BG 79(B&B1) LARGE BOW ROLLER

Total length - 220mm long x 130mm wide

Roller wheel - 76mm dia x 39mm wide



BG 80 LARGE SAMPSON POST

Base - 86mm x 76mm

Total height - 78mm high

Stem - 38mm dia

BG 80(A) SMALL SAMPSON POST

Base - 59mm square

Total height - 68mm high

Stem - 25mm dia



BG 79(A3)
BOW ROLLER with
SAMPSON POST - small



Anchors



R4-021 FOLDING ANCHORS

R4-021-0.7 0.7KG FOLDING ANCHOR

R4-021-1.5 1.5KG FOLDING ANCHOR

R4-021-2.5 2.5KG FOLDING ANCHOR

R4-021-3.2 3.2KG FOLDING ANCHOR

R4-021-4 4.0KG FOLDING ANCHOR

R4-021-6 6.0KG FOLDING ANCHOR

R4-022 DANFORTH ANCHORS

R4-022-2.5 2.5KG DANFORTH ANCHOR

R4-022-3.5 3.5KG DANFORTH ANCHOR

R4-022-4 4.5KG DANFORTH ANCHOR

R4-022-6 6.0KG DANFORTH ANCHOR

R4-022-8 8.0KG DANFORTH ANCHOR



Boat Accessories

BG145(A-C1) TELESCOPIC & FIXED BOAT HOOKS

Standard - Extends from 1.3M to 2.2M

A - 1.8M long (fixed length)

A2 - 1.2M to 2.5M long

A3 - 1.7M to 3M long

B - 2.7M to 5M long

C - 3.1M to 6M long

C1 - 3M to 6M no hook



BG144

PLASTIC MOTO MUFF



BG139(A) DOUBLE PADDLE

Double plastic paddle with aluminium stem
2.1m total length - splits in the middle.



BG139(B,B1&D) SINGLE PADDLES

Single plastic paddle with aluminium stem.

B - 1.05 meters total length

B1 - 1.28 meters total length

D - 1.5 meters total length

Available in black only.

Paddle blade, T-handle available separately.



BG 59 UTILITY PUMP

Bilge pump with filter.



BG 70 (Side)
ROWLOCK WITH
SIDE MOUNT BUSH



BG 70 (Top)
ROWLOCK WITH
TOP MOUNT BUSH

Made from Acetal (Hostaform).



BG 70(A)
ROWLOCK TOP
MOUNT BUSH ONLY



BG 70(B)
ROWLOCK SIDE
MOUNT BUSH ONLY



BG 70 (C) ROWLOCK ONLY

INF005 Valve Adapter

From compressor/inflator to valve (Boston / Roberts).



6001-023811493

PUMP DBL ACTION 48cm
BOXED



98970 Valve Adapter

From hand pump to valve
(Boston / Roberts)





Boat Fenders—OCEAN H-series

H2 - 14 x 40cm

H3 - 16 x 56cm

H5 - 22 x 64cm

Safety



BG 134

MOUTH FOG HORN

Plastic.



BG 120 S/S MIRROR

Size - 100mm x 100mm.



PFD1-ALL - Paddling / Ski 50N

25-40Kg / 40-70Kg / 70-90Kg / 90+kg

PFD12ALL- Paddling / Ski 50N
30-50Kg / 50-70Kg / 70-90Kg / 90+kg



Adult Life Jacket - 100N + 150N
70-90 Kg or 90+ Kg



Baby Life Jacket - 100N
15-30Kg or 30-40Kg

Electrical

Switches



B5-027-4 Switch Panel AAA 4 switch 8x9 in BLK

B5-028-4 Switch Panel AAA 4 switch 8x9 in WHT



B5-027-6

Switch Panel AAA 6 switch in BLK/WHT

AES-118-36

SWITCH - Toggle - WATER PROOF



AES-1118-42

SWITCH COVER W/PROOF - FOR SWITCH SW613 / 9

SW613 SWITCH – METAL TOGGLE – ON/OFF

SW619 SWITCH – METAL TOGGLE – ON/OFF/ON



Lights / Navigation Lights



8544

Navigation light - Running (Port and Starboard)

Bow Mount

B5-020 (Black) / B5-021 (White)

Navigation light - Running (Port and Starboard)

Available in Black or White housing and with incandescent or LED.

-1 / 1LED : Port / Port-LED

-2 / 2LED : Starboard / Starboard-LED

-4 / 4LED : Stern

Incandescent can also be upgraded to LED with purchase of LED cartridge bulb.



Cartridge LED replacement bulbs

250ALED 32mm 16 LED's

2165 42mm 4 LED's



L4-002B

LED x 3 white light

Ideal for trailer number plate or inside gunnel—shines downwards

B5-043-1 Anchor Light- fold down

B5-048-C Anchor Light- fixed



Battery Components



Battery Boxes - complete with securing strap and kit

BB2 - 275mm x 180mm x 200mm

BB3 - 325mm x 180mm x 200mm

BB5 - 420mm x 200mm x 210mm



B3-001 - Battery Terminals

Solid Brass - with convenient wing nuts for easy removal of battery

We recommend you remove battery and leave on a trickle charger. Leisure batteries (deep cycle) are expensive and must be maintained to ensure long life. Leaving a battery through winter without trickle charging will drastically shorten its life span. Plus they are prone to being stolen when left on boats—along with fuel tanks and any loose stainless fittings.

Guardian Battery Switches

69x69mm 48V 200A

YIBF441 - on/off - single battery

YIBF442 - 1/2/both-off - dual battery



SFBIS101 - Seaflo 12v Battery Isolator Switch With Cover

- Can be connected to either the positive or the negative electric cable.
- In the "OFF" position the key may be removed.



YIAS212A - Guardian 12V Power Socket

- Panel mount and anti-splash cap.
- Rating: DC 9-36V 20A
- Twist-and-Lock capability when used with AP121

YIAS234A - Guardian 2P USB Charger

- Panel mount and anti-splash cap.
- Input: DC 12-24V (Dual Voltage)
- Output: DC 5V 2.4A (AS233) / 5V 3.4A (AS234)
- Optimized for latest iPad& iPhone - Compatible with other smartphones



YIAS245PU - Guardian Cig Lighter Socket & 1P USB Charger Comb

- Panel mount and anti-splash cap.
- Input: DC 12-24V (Dual Voltage)
- Output: DC 5V 2.4A



USE TO MOUNT FISHFINDER TRANSDUCER ON TRANSOM

BG 51 STOPS

Nylon Track Stops (Per set)



BG 51 SPACERS

Nylon Track Spacers (Per set)

BG 160 - BG 172 ALUMINIUM TRACKS

Available in various lengths with or without index pin holes & counter-sunk screw holes.

Black or natural anodising option available.

Please refer to price list for codes and options.



BG 53

Blank slide with nylon runners & index pin with knob
(92mm long) Black or Natural anodised.

Marine Pumps



SFDHPG72001

Manual Diaphragm Hand Pump

Plastic Handle 720 Gallon

Seaflo Non-Auto Bilge Water Pump 12V

Non-automatic bilge pumps offer water evacuation activated by a panel or float switch. Has a larger impeller design and more robust motor. The removable strainer base fits industry standard mounting conventions.

FEATURES & BENEFITS



- SFBP1G35001 - 350 GPH
- SFBP1G50001 - 500 GPH
- SFBP1G75001 - 750 GPH
- SFBP1G110001 - 1100 GPH

FEATURES & BENEFITS



- SFBP2G150001 - 1500 GPH
- SFBP1G200001 - 2000 GPH

FEATURES & BENEFITS



- SFBP1G350001 - 3500 GPH
- SFBP2G470001 - 4700 GPH

SFBS1802 - Seaflo Float Switch

For pumps drawing up to 20 amps. Designed for use with fresh water and salt water only.

FEATURES & BENEFITS



Seaflo Auto Bilge Water Pump 12V

Automatic all-in-one pump & float switch. No additional float switch required. Pump turns on when water level rises & shuts off when water is removed.

- SFBP1G75006 - 750 GPH
- SFBP1G110006 - 1100 GPH

FEATURES & BENEFITS



OUTBOARD RELATED

Control Cables & Accessories

RI620000801 Control Box

CM01 Single Lever

Reversible accelerator direction

Neutral throttle warm up



Control Cables Co42

Quality Mavi Mare Control Cables Made in Italy

Stroke 87mm standard engine control cable 7.0mm diameter.

Available in 12 ft - 30 ft



AES-1213 Lanyard Cut-off switch

12C Cut-off switch with lanyard

12RC Lanyard only



Steering Systems - Mechanical

MMG12

Helm G12 including Bezel

Manufactured in Italy.

- Interchangeable with T.67 Ultraflex and SH8050 Teleflex
- Packaged with 90° bezel kit



Measure Conduit D for Length of Cable



How to measure for replacement steering cables

Order length: "D" dimension + 22" and round up to the next whole foot.

Example: $D = 133" + 22" = 155"$ (12'9").

Round up to 13 ft.

Mechanical Steering Cables

Steering Cable MaviMare C17—Made in Italy

- Interchangeable with M.66 Ultraflex and SSC 62 Teleflex
- Minimum steering cable bend radius 200 mm
- Available in 8 ft - 20 ft



MMCA245 - Link Arm

- Adjustable Reinforced 316 Stainless Steel
- Universal fitting suitable for most outboard motors



Steering Wheel

MMVLN32 - Ultra tough Black nylon, 320mm

B5-409 - Ultra tough Black nylon, 340mm



BG60A - Motorwell Boot SMALL

(A2) boot only

(A3) ring only



BG60B

(B2) Large motowell boot only

(B3) Large trim ring only



C5-014-21

21mm—ideal for steering and control cables

Packet of 10m





HydroFoil

10121 - Small - for upto 50Hp

10122 - Large - for over 50Hp

Fuel

HULK Fuel Tanks

44803 12LT

44804 24LT



PJ25 Upright Clear Fuel Tanks

25L—complete with cap.

Uses BG136(A) Fuel Pick-Up.

BG 136 JERRY CAN FUEL PICKUP

Jerry can with fuel pick-up (old style)

A - Jerry can cap only with sealing ring (old style)

B - Jerry can cap with fuel pickup (Addis 25l can)

C - Jerry can cap only with sealing ring (Addis 25l can)

D - Jerry can cap elbow only



BG 143 JIGGLE PUMP

Packaged.

Pipe size - 12mm ID x 2M long.

YBo402X7

Primer Bulb - (3/8inch) 8mm



YBo410X7M/YBo410X7

Fuel Pump Joint - 8mm - 3/8 in Motor side/Tank Side

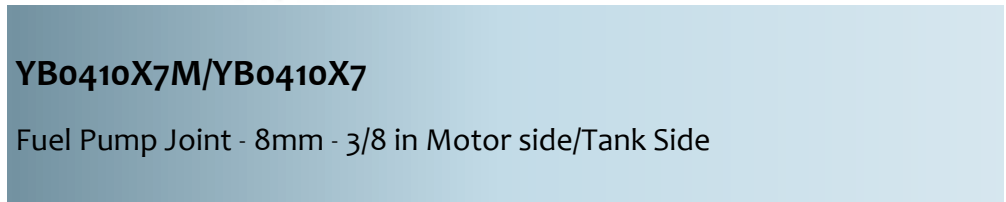

Boat Cover edge fasteners

EYELETS (Metal)

Heavy duty Brass or Stainless Steel (304) eyelets with “spurs” to grip onto material.

(Male / Female pairs)

TG4 Dimension: ID 9mm OD 20mm

TG7 Dimension: ID 12mm OD 26,5mm

(A) TG4 Solid Brass

(B) TG4 Stainless Steel

(C) TG7 Solid Brass

(D) TG7 Stainless Steel

Retail Pack: Qty 10 / **W/Sale:** Bag of 50



Hand closing tools and Hole punches

TG4 or TG7



BG68 (I)

Plastic Eyelets (Male / Female pair) (Black or White Nylon)

No special closing tool required (hammer close)



HOLDON Midi—Removeable, Reusable, Emergency Repair Eyelet

Plastic Eyelets (Black or White Nylon)



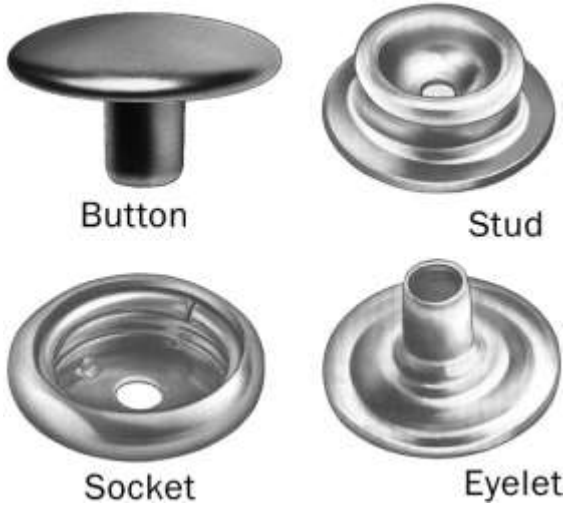

Press Studs—Stainless SK50/24

- 997858 Button / Cap
- 997859 Socket (Female)
- 997860 Stud (Male)
- 997861 Eyelet (used for cloth to cloth applications)



SNADS (Snap ADheSive attached)

Unlike traditional metal trims, SNAD® is a plastic adhesive snap component.

This product will not snag clothing or deteriorate from exposure to sunlight, sand, or dirt. Plus, walking on SNAD® is pain free due to its unique dome shape.

Installation is simple, clean the surface where the snap is to be applied, peel off the protective paper backing, position and firmly hold the snap in place and release.

No tools, no holes / screws!

- 40mm diameter
- Male (Snap) or Female (Socket)
- Black or White

Trailer

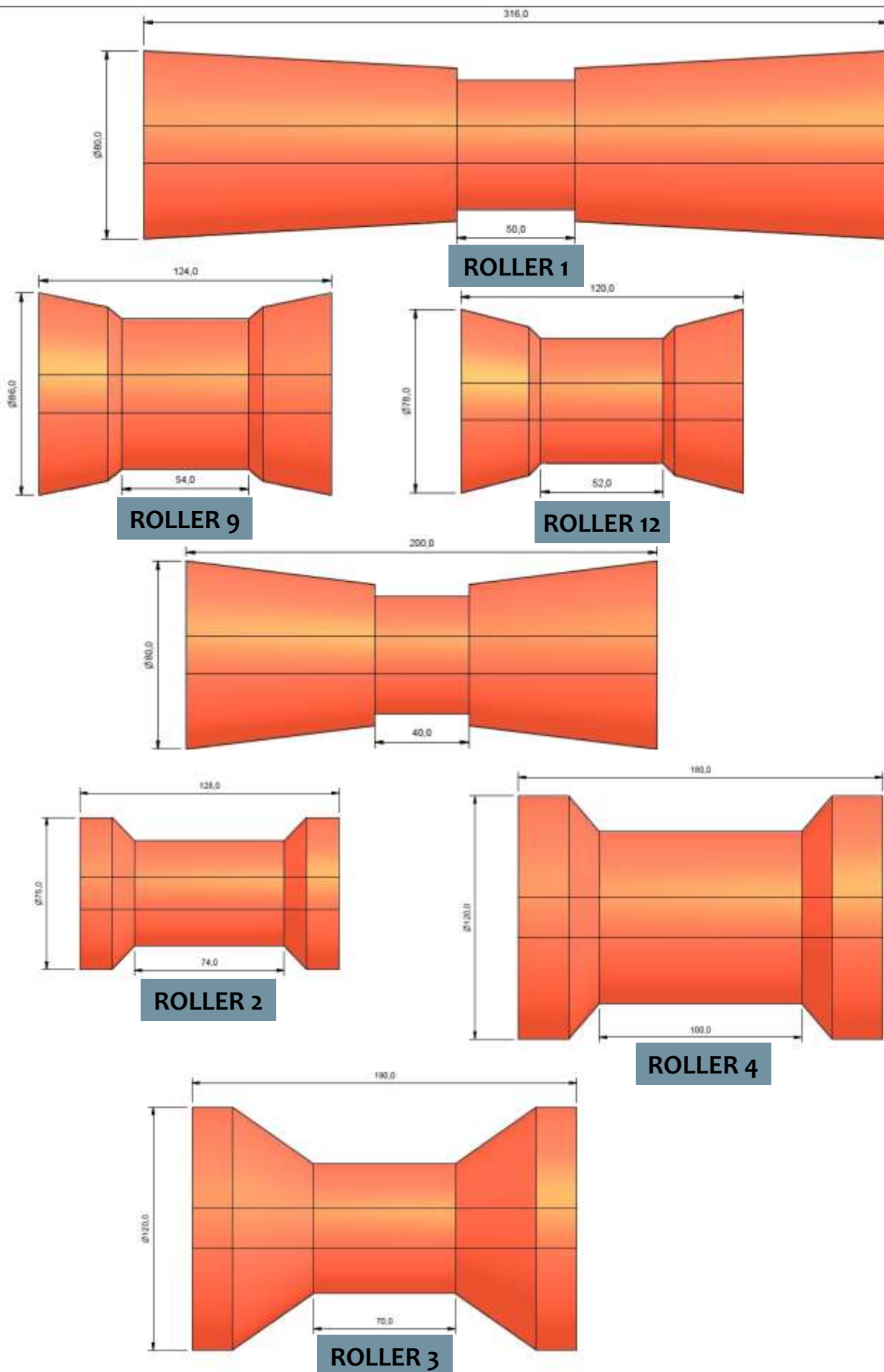

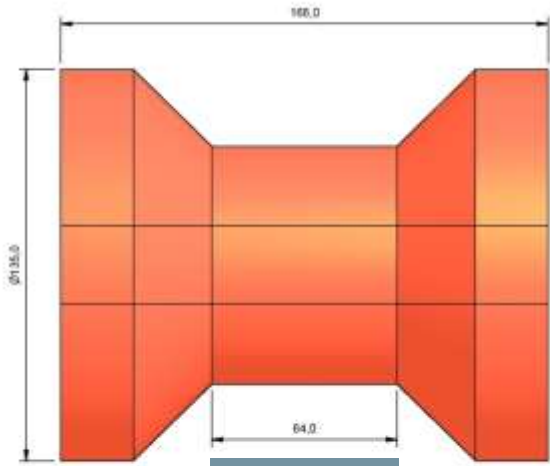

ROLLER 5

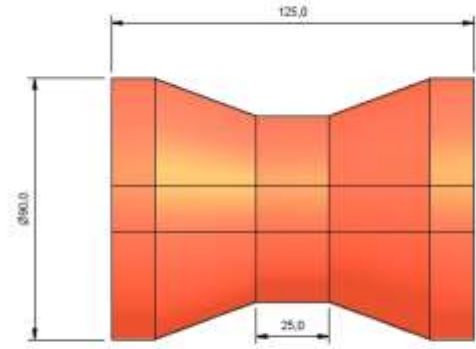

ROLLER 8

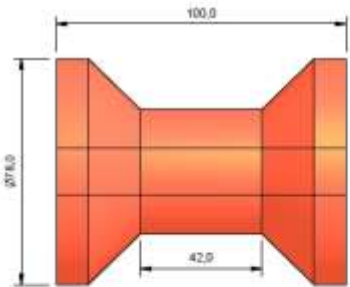

ROLLER 10

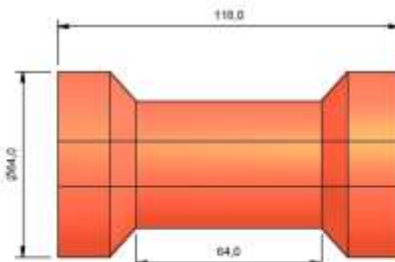

ROLLER 11



ROLLER PINS
140mm—
360mm

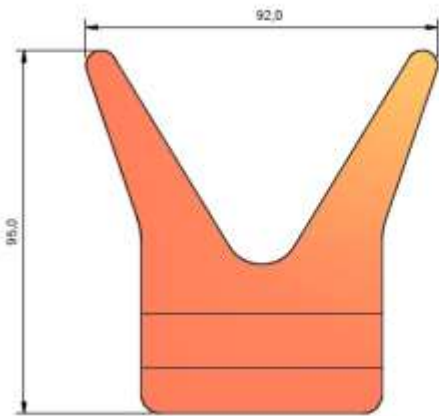

V-BLOCK 18

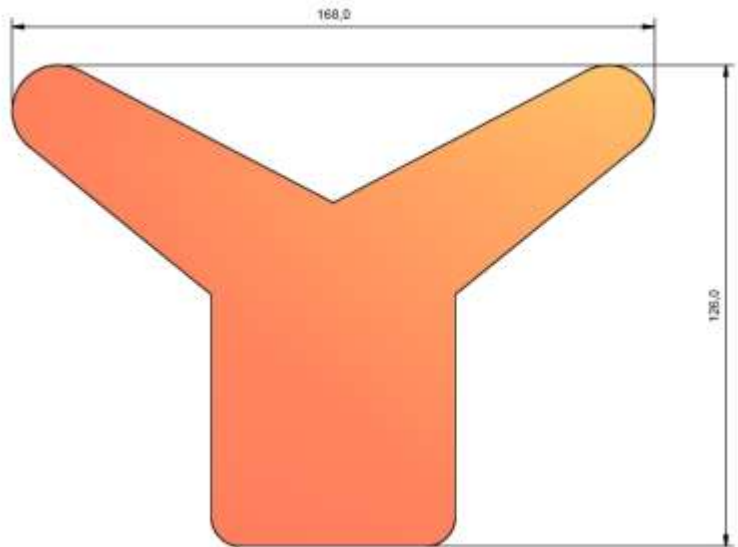

V-BLOCK 90

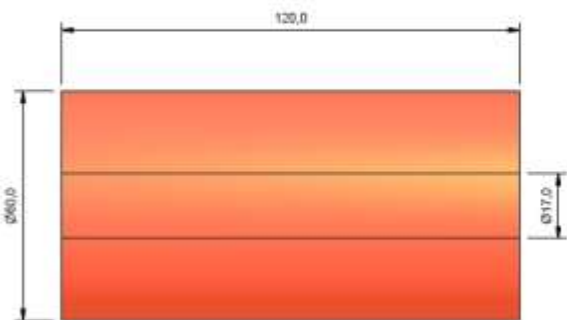

ROLLER 14

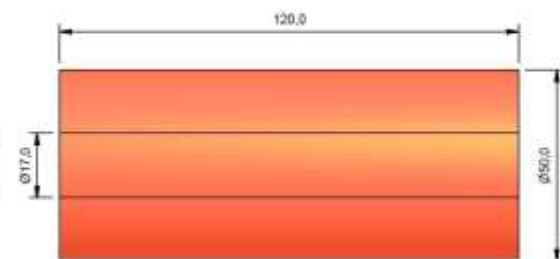

ROLLER 13



TRAILER FELT

For lining boat trailer skegs. Gentle on boat, cushioning to prevent gel-coat starring and boat less likely to slip during transport. Easy application - ensure clean, rust free substrate and use general purpose contact adhesive.

10mm thick, 10m rolls – sold per meter

Available in 50mm, 75mm and 100mm wide



WT-75-08 Galvanized

850lb / 385Kg hand winch

Single Gear / Single Speed



FJ05 Galvanized

1400lb / 635Kg hand winch

Single Gear / Single Speed

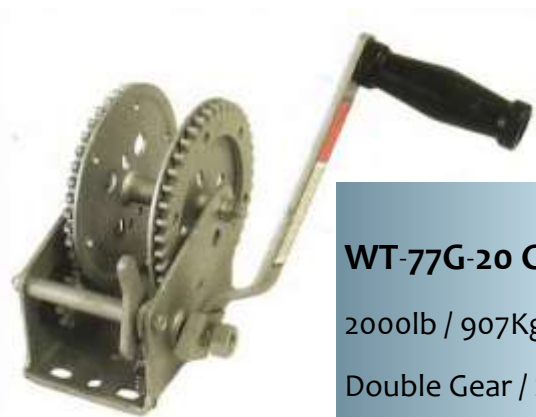

WT-77G-20 Galvanized

2000lb / 907Kg hand winch

Double Gear / Single Speed

CL-WS

Winch Strap 3 Ton webbing with 100mm S/S Spring gate Snap

5m & 7m lengths



WtT77-37 Electro plated

3700lb / 1678Kg hand winch

Double Gear / 2 Speed

Gear Ratios 5.1:1 & 12:1



CL-BRTD BOAT RATCHET TIE DOWN

- Better than turnbuckles/shackles/chain solution
- Easy on, easy off—never needs to go in water
 - Won't vibrate loose

CL-BRTD - L/D 25mm ratchet and webbing—for smaller boats

CL-BRTD 38 - H/D 38mm ratchet and webbing—for larger boats



ALTERNATIVE IS TURNBUCKLES + CHAIN + SHACKLES

The disadvantages of which are:

- Galvanized ones rust as they remain attached to the trailer when you launch boat in the water
- Stainless Turnbuckles tend to vibrate loose when travelling as the thread is so smooth
- Stainless have a tendency of being stolen as they are expensive components





B5-005-6

150Kg Jockey Wheel with 6" Rubber Wheel



B5-005-8

200Kg Jockey Wheel with 8" Rubber Wheel



WT-25-1

200Kg Jockey Wheel with 8" Rubber Wheel

(Heavier Duty clamp and overall better quality than B5-005-8)

WT-25-1W

350Kg Jockey 8" Wheel



WT-25-SP

250Kg Jockey Wheel Bracket

