

CCP

PRECAST CONCRETE

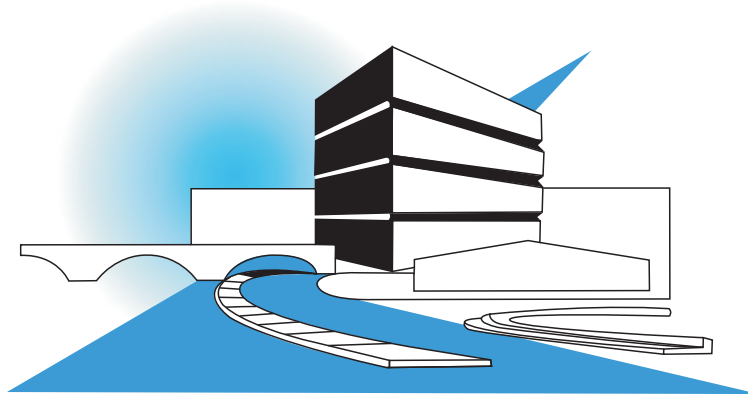

Fax: 0865 808 919

Cell: 083 412 1958

Office: 031 766 3373

www.ccpconcrete.co.za

Email: colinsconcrete@iburst.co.za

Ck No.2006/176785/23

Vat. 415 0232231

**P.O BOX 414, Hillcrest, 3650
81 Rd D819, Bracken hill industrial Waterfall, Durban, KZN**

PRECAST CONCRETE PRODUCT CATALOGUE

MANHOLE RINGS

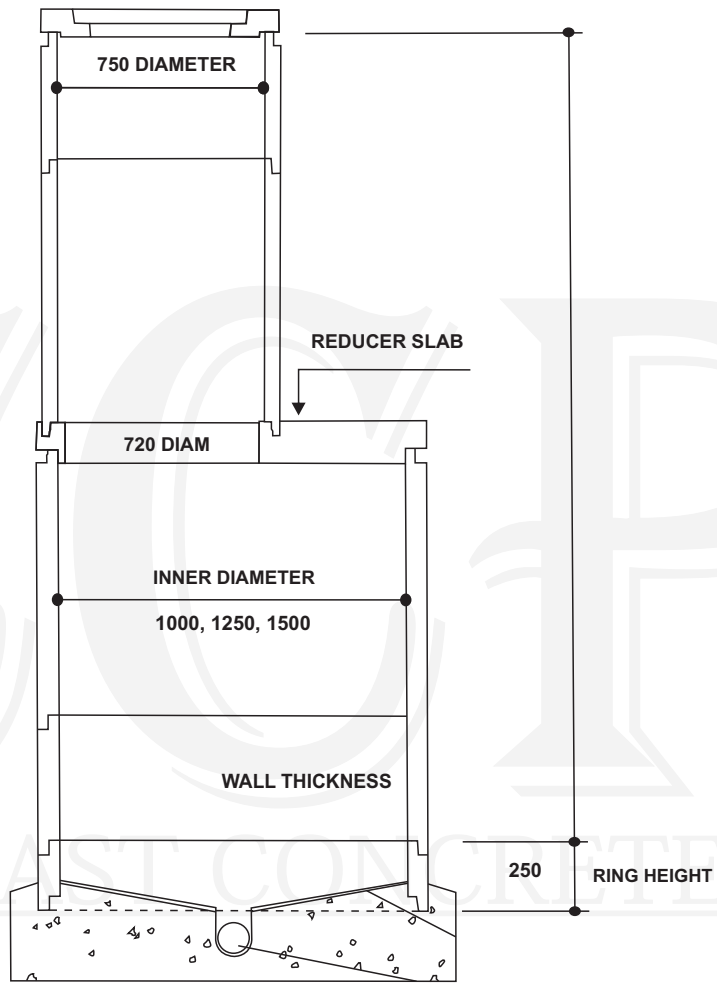

RING SIZES

INNER DIAMETER	RING HEIGHT	WALL THICKNESS
750	250	55
750	500	55
1000	250	65
1000	500	65
1250	250	75
1250	500	75

CATCH PIT COVERS & SPLAYS

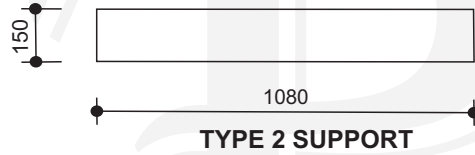
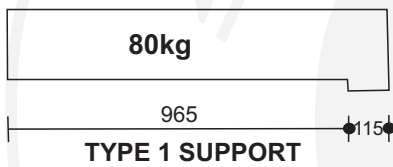
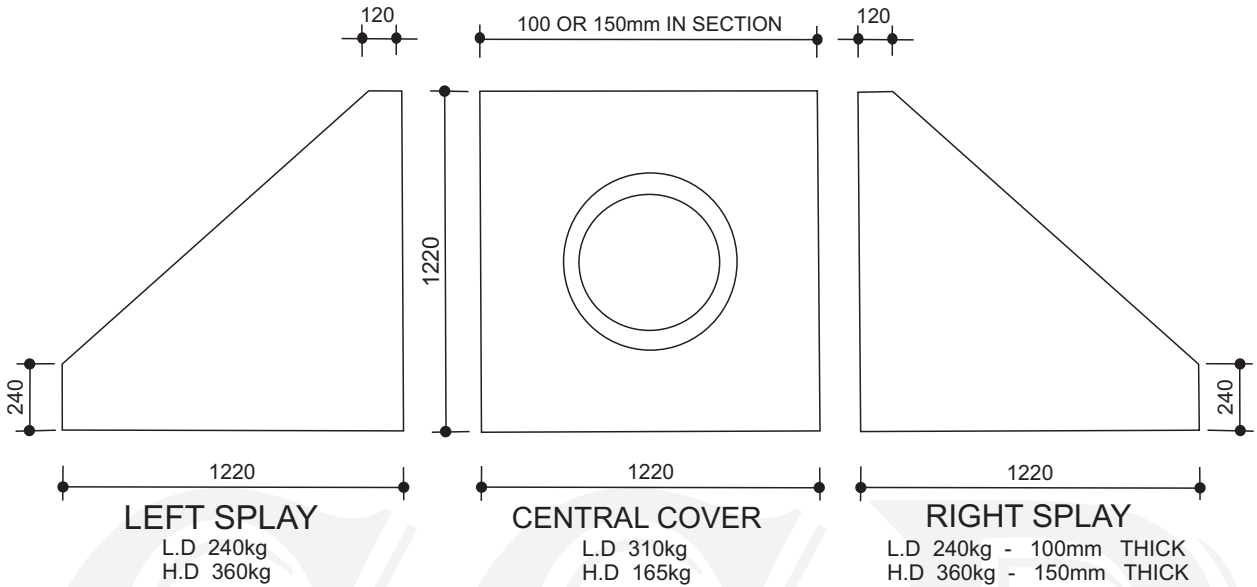

MANHOLE COVER & LIDS

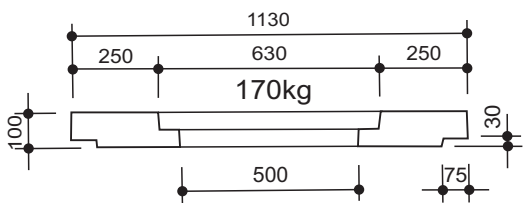
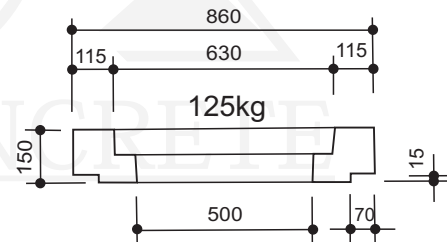
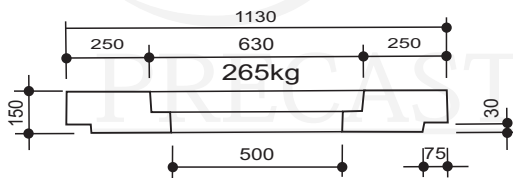

LIGHT DUTY

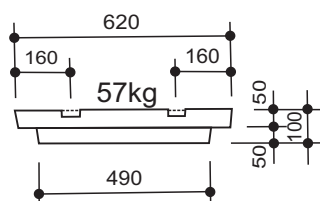
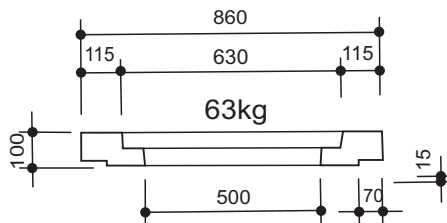

LIDS

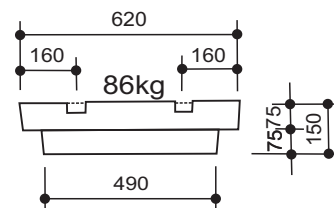

KERBS

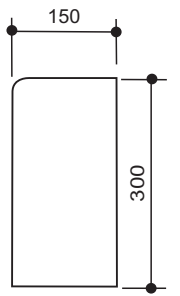

FIG 1 - 115KG

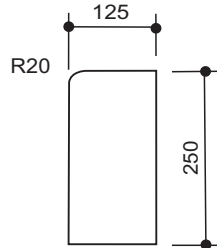

FIG 2 - 78KG

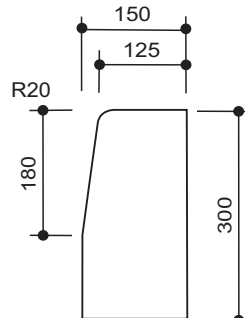

FIG 3 - 102KG

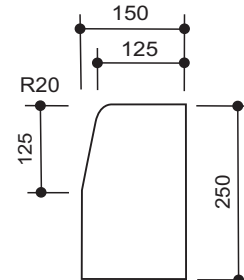

FIG 4 - 84KG

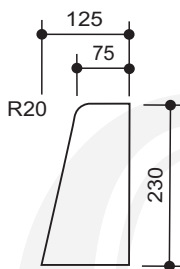

FIG 6 - 54KG

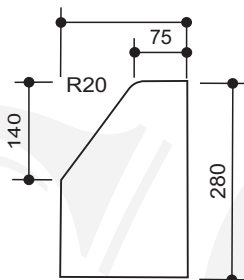

FIG 7 - 107KG

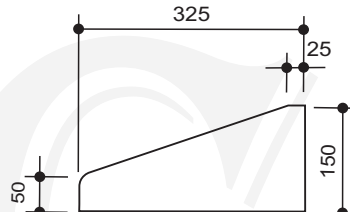

FIG 8 - 75KG

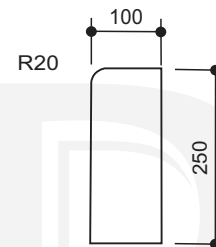
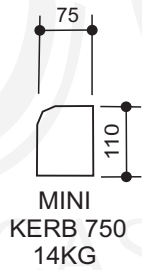

FIG 10 - 61KG



MINI
KERB 750
14KG

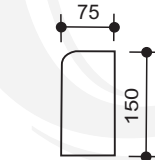

FIG 12
28KG

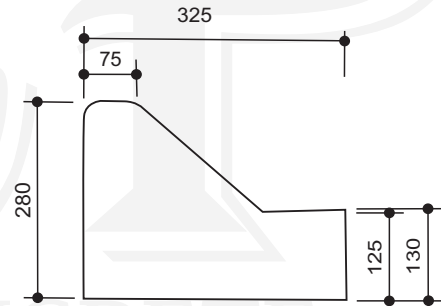
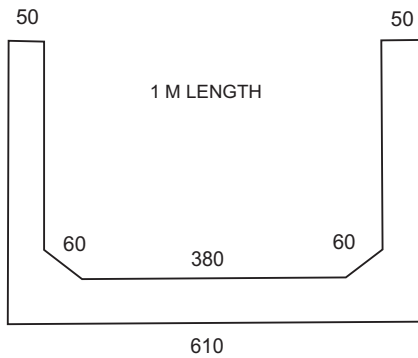
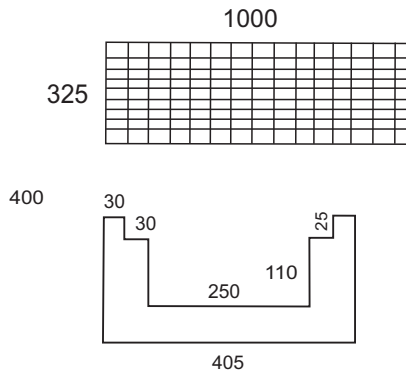

FIG 7 KERB & CHANNEL

SURFACE WATER CHANNELS



SWC 1 CHANNEL - 180KG



SWC 8 CHANNEL - 80KG

MENTIS GRATE TO
FIT SWC 8

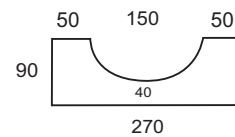

SWC 5 CHANNEL - 55KG

ALL CHANNELS / METER IN LENGTH

GRASS BLOCKS

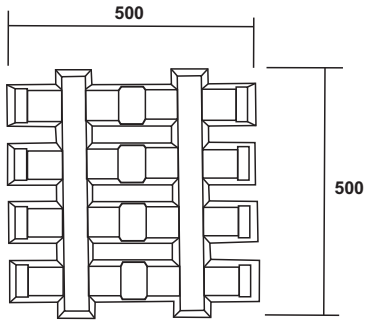

Grass blocks are the new generation driveway and parking lot alternative. This eco-friendly green product is designed to give maximum load bearing on the underside and maximum grassing area on the surface level.

Our blocks are considered heavy duty as they are reinforced through, making them extremely robust and able to take the heavy load of trucks and the same time giving you a pleasant natural looking parking bay or driveway that can be mowed. Installation is quick and easy as there are only four blocks per square meter, making them cost effective to lay.

Our blocks come in one size:

500 x 500 x 100 (reinforced)
4 per square meter

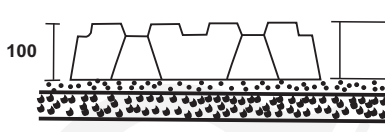

Fill in blocks with top soil and grass
20mm of Umgeni Sand
100mm of compacted DG or Soil

PAVERS & SLABS

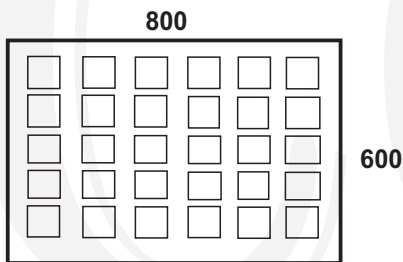

COBBLE PAVER 800X600X120

THE COBBLE PAVER CAN BE USED INSIDE FENCE LINES PREVENTING HOLES BEEN DUG UNDERNEATH FENCE, AND PROVIDING A PATH WAY AROUND THE INSIDE OF A FENCE LINE, IT HAS A 25MM HOLE THROUGH THE CENTER SO ELECTRICAL OR ALARM CABLES CAN BE RUN INSIDE THE BLOCK SAFELY.

IT CAN ALSO BE USED AS A HEAVY DUTY AND EASY TO LAY DRIVEWAY SOLUTION. BEING ABLE TO TAKE HEAVY TRUCKS AND BEING INSTALLED IN ON TIME AT ALL.

PRECAST CONCRETE

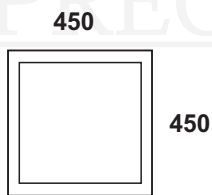

450 x 450 x 50
WITH WOOD FLOAT

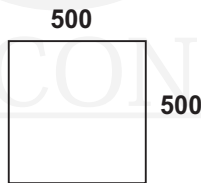

COBBLE PROTECTION
OR PAVER

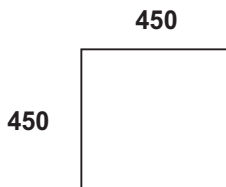

450 X 450 X 100 HEAVY
DUTY PAVER OR COOKIE
USED FOR OVER HEAD
POWER LINES AS BASE
MOUNTS

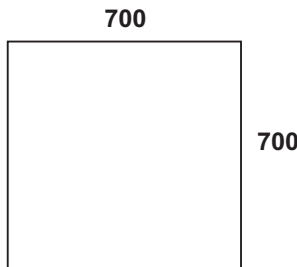

700 X 700 X 50 . USED FOR
BRIDGES AND PATH WAYS

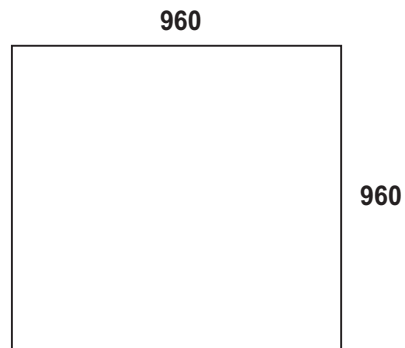

960 X 960 X REINFORCED PAVER

*** WE ALSO MAKE SLABS UP TO THE CUSTOMERS
NEEDS AND SPECIFICATIONS ***

Umbrella Stand

(A/F) 600 x 70

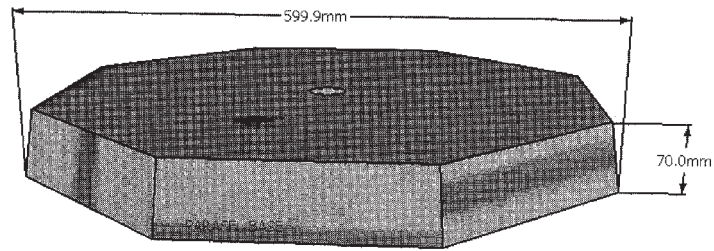

(Can be supplied with umbrella galvanised mount)

Fence Poles

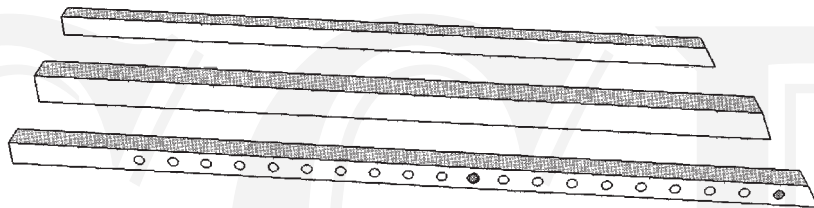

Electric: 2400 x 75 x 75
Plain: 2400 x 75 x 75
2400 x 100 x 100
3000 x 75 x 75
3000 x 100 x 100

Square Ring

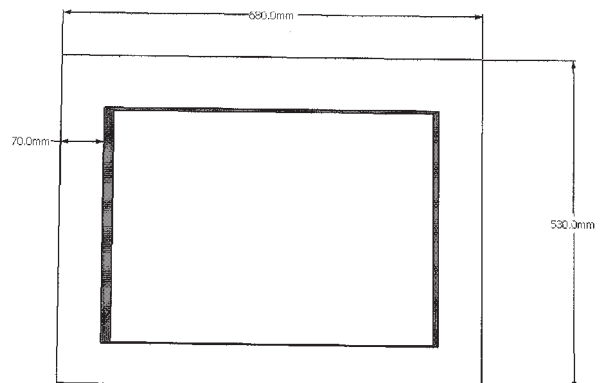
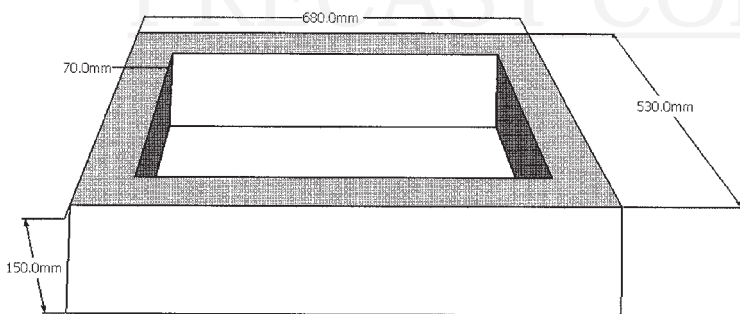

SEPTIC TANKS / STORM WATER TANKS / GREASE TRAPS

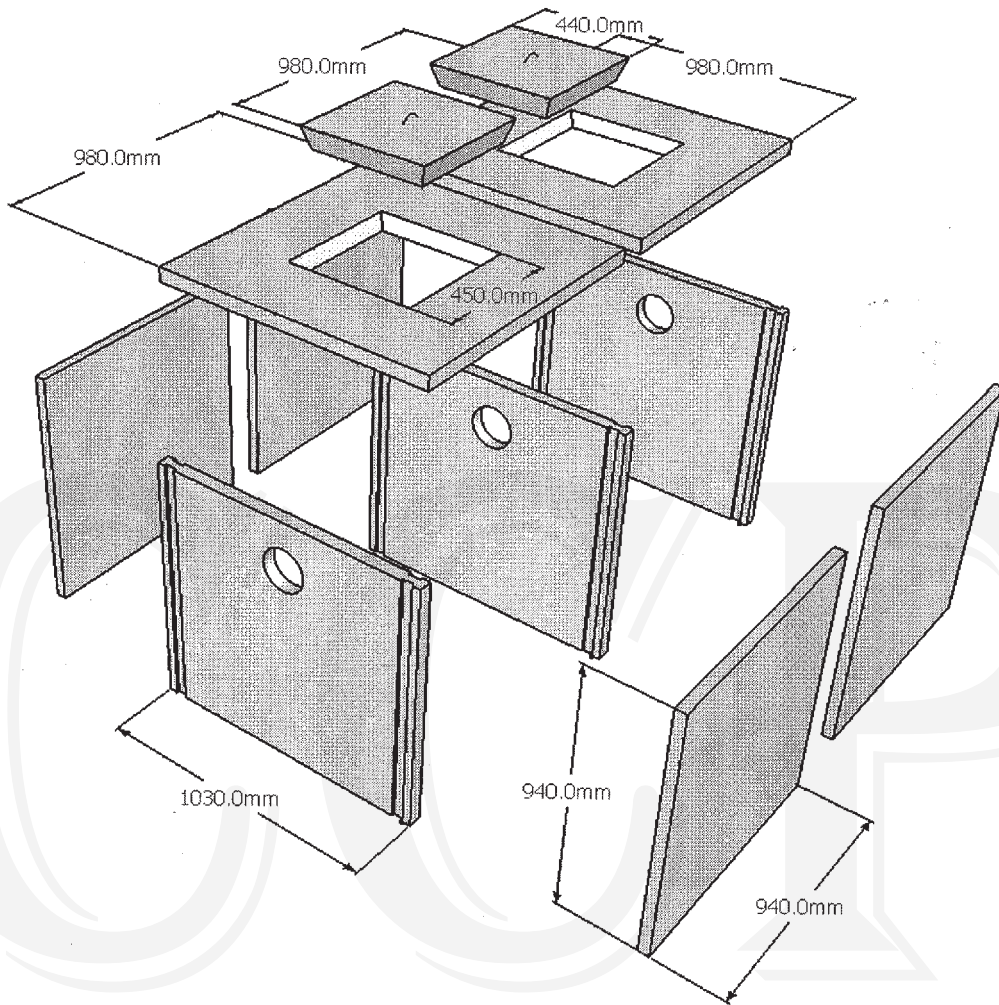

2, 3, 4 Compartments

TWO COMPARTMENT SEPTIC TANK

- CAPACITY OF 1500 LITRES (750 PER COMP)
- REINFORCED WITH 193 MESH 6MM
- ADDITIONAL COMPARTMENTS CAN BE ADDED, OPEN END PANELS FOR EASILY INCREASING EXISTING TANKS ***
- 160 MM INTERNAL HOLES

STORMWATER / GREASE TRAPS

- SAME DESIGN AS ABOVE EXCEPT THE 960 X 960 PANELS ARE CAST WITH 25.50MM HOLES IN IT, SO IT CAN BE USED TO CONTAIN STORM WATER AND LET IT SLOWLY FILTRATE OUT AT A CONTROLLED RATE.

-APPROVED BY ENGINEERS ON SITE.

